

C-15 Appeal Documents -  
T.I.A.

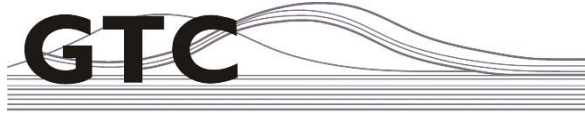

Gibson Traffic Consultants  
2813 Rockefeller Avenue  
Suite B  
Everett, WA 98201  
425.339.8266

# McGarigle Development Traffic Impact Analysis

Jurisdiction: City of Sedro Woolley

September 2019



---

## TABLE OF CONTENTS

1. INTRODUCTION.....	1
2. METHODOLOGY .....	1
3. TRIP GENERATION AND DISTRIBUTION.....	4
3.1 Trip Generation Calculations .....	4
3.2 Trip Distribution.....	5
4. WEEKDAY PM PEAK-HOUR ANALYSIS .....	8
4.1 Turning Movement Calculations.....	8
4.2 LOS Analysis .....	13
5. COLLISION DATA.....	13
6. ACCESS ANALYSIS .....	14
7. TRAFFIC MITIGATION FEES .....	14
8. CONCLUSIONS.....	15

## LIST OF FIGURES

Figure 1: Site Vicinity Map .....	2
Figure 2: Age-Restricted PM Peak-Hour Trip Distribution .....	6
Figure 3: Unrestricted PM Peak-Hour Trip Distribution.....	7
Figure 4: 2019 Existing Turning Movement Volumes.....	10
Figure 5: 2025 Baseline Turning Movement Volumes.....	11
Figure 6: 2025 Future with Development Turning Movement Volumes .....	12

## LIST OF TABLES

Table 1: Level of Service Criteria for Intersections.....	3
Table 2: ITE Land Use Codes.....	4
Table 3: Trip Generation Summary – Age-Restricted Scenario.....	4
Table 4: Trip Generation Summary – Unrestricted Scenario .....	4
Table 5: Intersection LOS Summary – PM Peak-Hour .....	13
Table 6: 5-Year Collision Rate Calculation.....	14

**ATTACHMENTS**

Trip Generation Calculations ..... A  
Turning Movement Counts ..... B  
2025 Turning Movement Calculations ..... C  
Level of Service Calculations ..... D  
Collision Data ..... E  
Pipeline Projects..... F  
Channelization Warrants..... G  
Sedro Woolley Six-Year TIP ..... H  
Sedro Woolley Traffic Impact Fee Documents ..... I

## 1. INTRODUCTION

Gibson Traffic Consultants, Inc. (GTC) has been retained to provide an analysis of the impacts of the McGarigle development in the City of Sedro Woolley. The development is proposed to consist of 85 residential units. The McGarigle development is located on the south side of McGarigle Road, east of Carter Street. The development is proposed to have one access to McGarigle Road opposite of the existing Independence Boulevard/McGarigle Road intersection. A site vicinity map is included in Figure 1.

Zach Wieben, responsible for this report, is a licensed professional engineer (Civil) in the State of Washington and member of the Washington State section of the Institute of Transportation Engineers (ITE).

## 2. METHODOLOGY

Scoping discussions with the City of Sedro Woolley staff identified two off-site intersections to be analyzed. The proposed site access to McGarigle Road was also analyzed for level of service and channelization warrants under the future with development conditions. The three intersections analyzed during the PM peak-hour in this report are listed below.

1. SR-9 at John Liner Road/McGarigle Road
2. McGarigle Road at Independence Boulevard/Site Access
3. McGarigle Road at Fruitdale Road

The 85 residential units within the McGarigle Development may be age-restricted units for seniors 55 years and older; however, that determination has yet to be made. Intersection analysis for the off-site intersections and the site access were analyzed with no age restrictions for the development (i.e. a higher vehicle trip generation) to perform a conservative level of service analysis. Trip generation and traffic mitigation fee calculations for both the age-restricted and unrestricted development scenarios are included in the report.

Intersections were analyzed during the 4-6 PM typical afternoon commuter peak period. The existing count data at the study intersections is based on data collected by the independent count firm Traffic Data Gathering (TDG), collected in 2019. The trip generation calculations were performed using data from the Institute of Transportation Engineers (ITE) *Trip Generation Manual, 10<sup>th</sup> Edition (2017)*. The intersection analysis has been performed using existing channelization, phasing, intersection peak-hour factors, and intersection heavy vehicle factors from the existing turning movement counts. The intersection level of service has been reported for each study intersection.

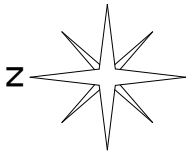

09/23/2019

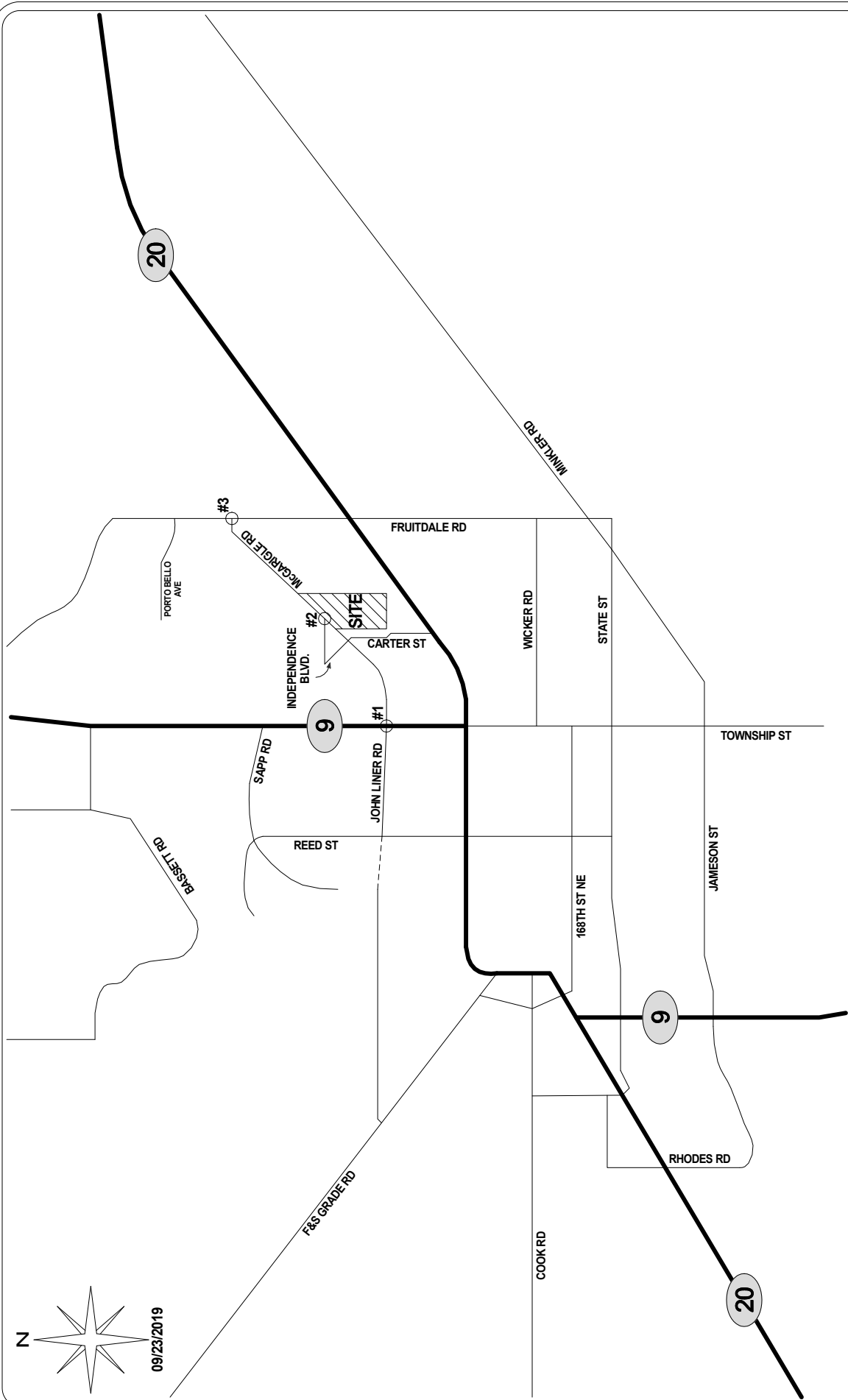



**TRAFFIC IMPACT STUDY**  
GTC #19-229

**FIGURE 1**  
**SITE VICINITY**  
**MAP**

**GIBSON TRAFFIC CONSULTANTS**

**McGARIGLE DEVELOPMENT**  
**51 NEW DETACHED UNITS**  
**34 NEW TOWNHOMES**  
**CITY OF SEDRO WOOLLEY**

- LEGEND**
-  DEVELOPMENT SITE
  -  STUDY INTERSECTION
  -  FUTURE ROAD

The peak-hour level of service (LOS) analysis calculations were completed using the *Synchro 10.2, Build 0* software for signalized and unsignalized intersections. This software applies the operational analysis methodology of the *Highway Capacity Manual 6<sup>th</sup> Edition (HCM)*. Traffic congestion is generally measured in terms of level of service. In accordance with the HCM 6<sup>th</sup> Edition, road facilities and intersections are rated between LOS A and LOS F, with LOS A being free flow and LOS F being forced flow or over-capacity conditions. Analysis of the roundabouts was performed using *Sidra Intersection 8.0* software. It is important to note that the volumes included in the Sidra results printouts account for the peak-hour factor, the volumes in the printouts are not the input volumes. The results for the roundabout analysis have been evaluated based on volume-to-capacity (v/c) ratio and the level of service. WSDOT evaluates roundabouts on a pass/fail basis, with a v/c ratio of 0.92 on any approach being the threshold. The level of service criteria is summarized in Table 1. The level of service at two-way stop-controlled intersections is based on the average delay of the worst approach. The level of service at signalized and all-way stop-controlled intersections is based on the average delay for all approaches. Geometric characteristics and conflicting traffic movements are taken into consideration when determining level of service values.

**Table 1: Level of Service Criteria for Intersections**

Level of <sup>1</sup> Service	Expected Delay	Intersection Control Delay (Seconds per Vehicle)	
		Unsignalized Intersections	Signalized Intersections
A	Little/No Delay	≤10	≤10
B	Short Delays	>10 and ≤15	>10 and ≤20
C	Average Delays	>15 and ≤25	>20 and ≤35
D	Long Delays	>25 and ≤35	>35 and ≤55
E	Very Long Delays	>35 and ≤50	>55 and ≤80
F	Extreme Delays <sup>2</sup>	>50	>80

The City of Sedro Woolley's level of service standard for SR-20, SR-9, and principal arterials is LOS D. The City of Sedro Woolley's level of service standard for minor arterials and major collectors is LOS C.

<sup>1</sup> **Source:** *Highway Capacity Manual 6<sup>th</sup> Edition*.

LOS A: Free-flow traffic conditions, with minimal delay to stopped vehicles (no vehicle is delayed longer than one cycle at signalized intersection).

LOS B: Generally stable traffic flow conditions.

LOS C: Occasional back-ups may develop, but delay to vehicles is short term and still tolerable.

LOS D: During short periods of the peak hour, delays to approaching vehicles may be substantial but are tolerable during times of less demand (i.e. vehicles delayed one cycle or less at signal).

LOS E: Intersections operate at or near capacity, with long queues developing on all approaches and long delays.

LOS F: Jammed conditions on all approaches with excessively long delays and vehicles unable to move at times.

<sup>2</sup> When demand volume exceeds the capacity of the lane, extreme delays will be encountered with queuing which may cause severe congestion affecting other traffic movements in the intersection.

### 3. TRIP GENERATION AND DISTRIBUTION

#### 3.1 Trip Generation Calculations

The McGarigle development is proposed to consist of 85 residential units. The development is proposed to consist of 51 detached units and 34 attached townhome units. The development could be age-restricted for seniors 55 years and older or it could have no age restrictions. The ITE Land Use Codes (LUC) for the attached and detached units for both the age-restricted and unrestricted scenarios are shown in Table 2.

**Table 2: ITE Land Use Codes**

Unit Type	Number of Units	ITE Land Use Code	
		Age-Restricted (55+ Years)	Unrestricted
Detached	51	ITE LUC 251 Senior Housing Detached	ITE LUC 210 Single-Family Detached
Attached	34	ITE LUC 252 Senior Housing Attached	ITE LUC 220 Multifamily Low-Rise

Trip generation calculations for the age-restricted scenario are summarized in Table 3.

**Table 3: Trip Generation Summary – Age-Restricted Scenario**

Land Use	# Units	ADT	AM Peak-Hour			PM Peak-Hour		
			In	Out	Total	In	Out	Total
LUC 251, Senior Housing, Detached	51	218	4	8	12	9	6	15
LUC 252, Senior Housing, Attached	34	126	2	5	7	5	4	9
<b>TOTAL</b>		<b>344</b>	<b>6</b>	<b>13</b>	<b>19</b>	<b>14</b>	<b>10</b>	<b>24</b>

Trip generation calculations for the unrestricted scenario are summarized in Table 4.

**Table 4: Trip Generation Summary – Unrestricted Scenario**

Land Use	# Units	ADT	AM Peak-Hour			PM Peak-Hour		
			In	Out	Total	In	Out	Total
LUC 210, Single-Family, Detached	51	481	9	28	37	32	19	51
LUC 220, Multifamily (Low-Rise)	34	249	4	12	16	12	7	19
<b>TOTAL</b>		<b>730</b>	<b>13</b>	<b>40</b>	<b>53</b>	<b>44</b>	<b>26</b>	<b>70</b>

As an age-restricted development, the McGarigle development would generate approximately 344 average daily trips, 19 AM peak-hour trips, and 24 PM peak-hour trips. As an unrestricted development, the McGarigle development would generate approximately 730 average daily trips, 53 AM peak-hour trips, and 70 PM peak-hour trips. Detailed trip generation calculations for each of the development scenarios are included in the attachments.

### **3.2 Trip Distribution**

It is estimated that 72% of the development's trips will travel along SR-20, sixty percent to and from the west and twelve percent to and from the east. Approximately 12% of the development's trips are expected to travel along Township Street, five percent to and from the south and seven percent to and from the north. An additional 11% of the trips from the development are expected to travel to local destinations along Township Street between John Liner Road/McGarigle Road and Wicker Road. The remaining 5% of the trips from the development are anticipated to travel along John Liner Road. Detailed trip distributions for the age-restricted and unrestricted PM peak-hour are included in Figure 2 and Figure 3, respectively.







---

#### 4. WEEKDAY PM PEAK-HOUR ANALYSIS

The scope of the level of service analysis performed as part of this report is based on scoping discussions between GTC staff and City of Sedro Woolley staff. Level of service at the following intersections has been analyzed for the weekday PM peak-hour:

1. SR-9 at John Liner Rd/McGarigle Rd
2. McGarigle Road at Independence Blvd/Site Access
3. McGarigle Road at Fruitdale Road

Level of Service for each of the study intersections was performed for the following scenarios:

- 2019 Existing Conditions
- 2025 Baseline Conditions
- 2025 Future Conditions with Development

The level of service analysis was performed using development trips from the unrestricted scenario which has the higher expected trip generation of the two scenarios (age restricted vs. unrestricted). Using the higher of the two trip generation scenarios results in a conservative (higher average vehicle delay) level of service analysis for potential mitigation.

##### 4.1 Turning Movement Calculations

The 2019 existing turning movements at the study intersections are based on data collected by the independent traffic count firm Traffic Data Gathering. The 2019 existing volumes at the study intersections are shown in Figure 4.

The 2025 baseline volumes were calculated by applying a 2% annually compounding growth rate to the existing volumes as well as pipeline trips from the Northern State Campus Planned Action and diverting trips from the John Liner Road Corridor Project. Traffic volumes at the study intersections for the “High Intensity Site Development” were added from a draft version of the Northern State Campus Planned Action EIS completed in 2015 by TSI, Inc. City of Sedro Woolley staff were not able to provide a final analysis and therefore inclusion of trips from the Northern State Campus Planned Action should be considered conservative and preliminary.

Improvement projects identified in the City of Sedro Woolley’s 2019-2024 TIP will construct roadway improvements creating a continuous arterial on John Liner Road/Jones Road from Township Street/SR-9 to F&S Grade Road. This new arterial will provide an alternative parallel route to SR-20 to help reduce congestion. Construction of intersection improvements at Township Street/SR-9 and John Liner Rd/McGarigle Road by WSDOT and the City of Sedro Woolley are expected to be complete in 2025 based on the City’s 2019 TIP. A report completed by TSI, Inc. for the City of Sedro Woolley in January 2019 identified the preferred intersection improvement to be a single-lane roundabout at this location. The TSI report identified approximately 255 additional eastbound trips in the forecast year 2036 on John Liner Road west of Township Street/SR-9 as a result of the arterial and intersection improvements. These additional trips were

added to the 2025 background growth forecast for the McGarigle development analysis based on the 2036 eastbound turning movement splits in the TSI analysis. By including the additional growth expected on John Liner Road by the year 2036 in the 2025 forecast, the intersection volumes for the SR-9 and John Liner Road/McGarigle Road intersection should be considered conservatively high. The background improvement projects included in the 2025 future baseline analysis are either funded or included in the City of Sedro Woolley's Traffic Impact Fee (TIF) cost basis. The 2025 future baseline volumes are shown in Figure 5.

The 2025 future with development turning movement volumes were calculated by adding the unrestricted development trips to the 2025 baseline volumes. The 2025 future with development volumes are shown in Figure 6.

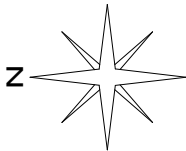

09/23/2019

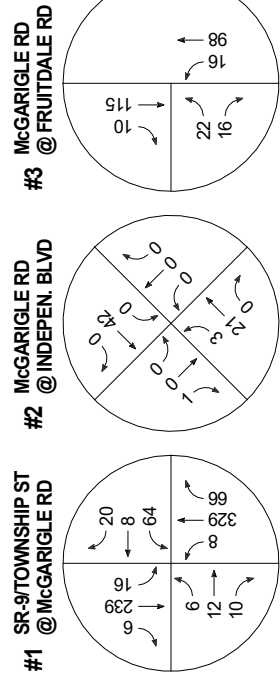
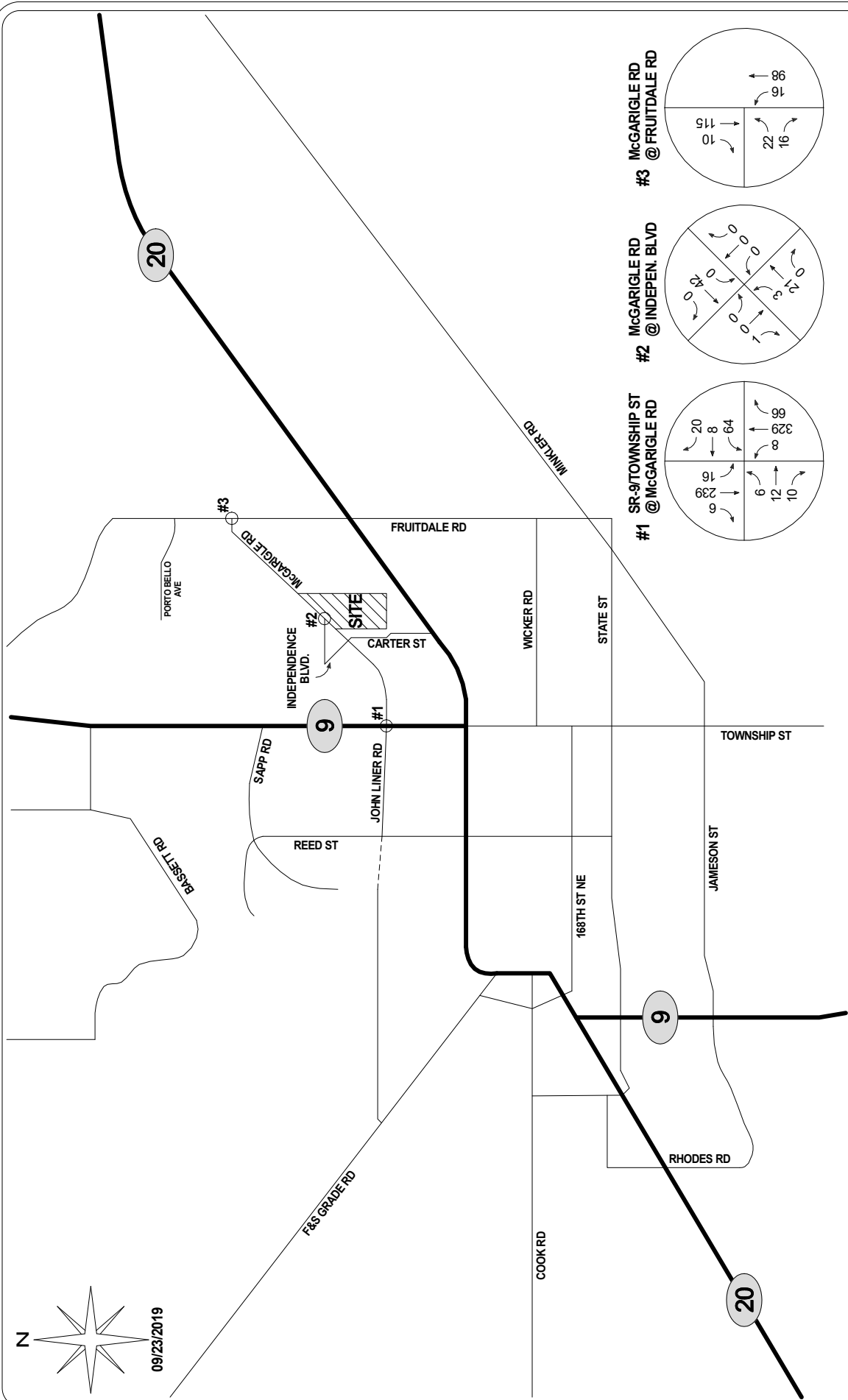

**TRAFFIC IMPACT STUDY**  
GTC #19-229

**FIGURE 4**  
**EXISTING**  
**TURNING MOVEMENTS**  
**PM PEAK-HOUR**

**GIBSON TRAFFIC CONSULTANTS**

**McGARIGLE DEVELOPMENT**  
51 NEW DETACHED UNITS  
34 NEW TOWNHOMES  
**CITY OF SEDRO WOOLLEY**

**LEGEND**

XX → PEAK HOUR TURNING MOVEMENT VOLUMES

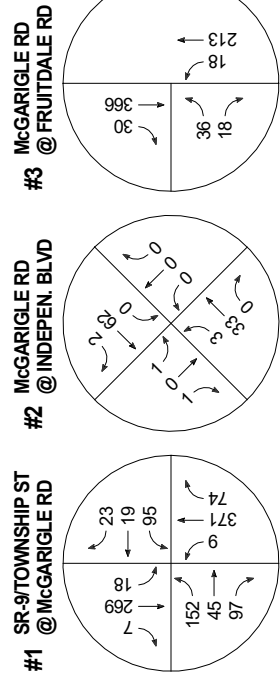
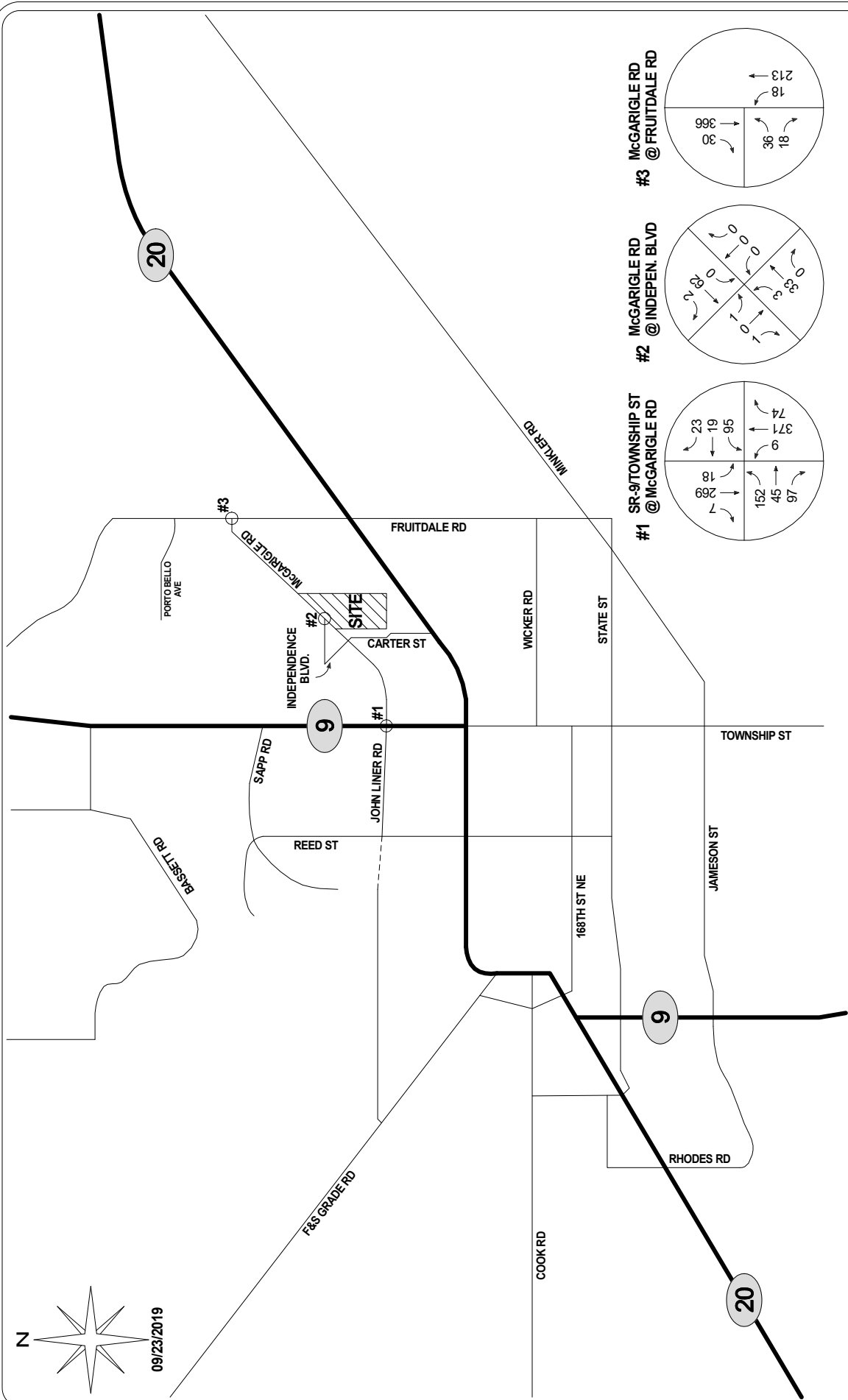
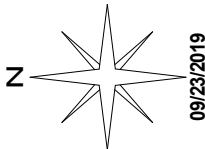

**TRAFFIC IMPACT STUDY**  
GTC #19-229

**GIBSON TRAFFIC CONSULTANTS**

**FIGURE 5**  
**2025 BASELINE**  
**TURNING MOVEMENTS**  
**PM PEAK-HOUR**

**LEGEND**  
XX → PEAK HOUR TURNING MOVEMENT VOLUMES

**McGARGLE DEVELOPMENT**  
51 NEW DETACHED UNITS  
34 NEW TOWNHOMES  
**CITY OF SEDRO WOOLLEY**

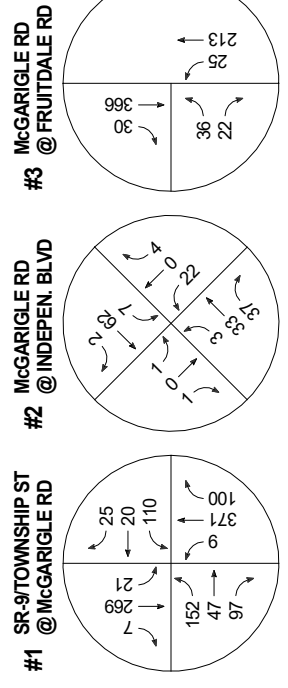
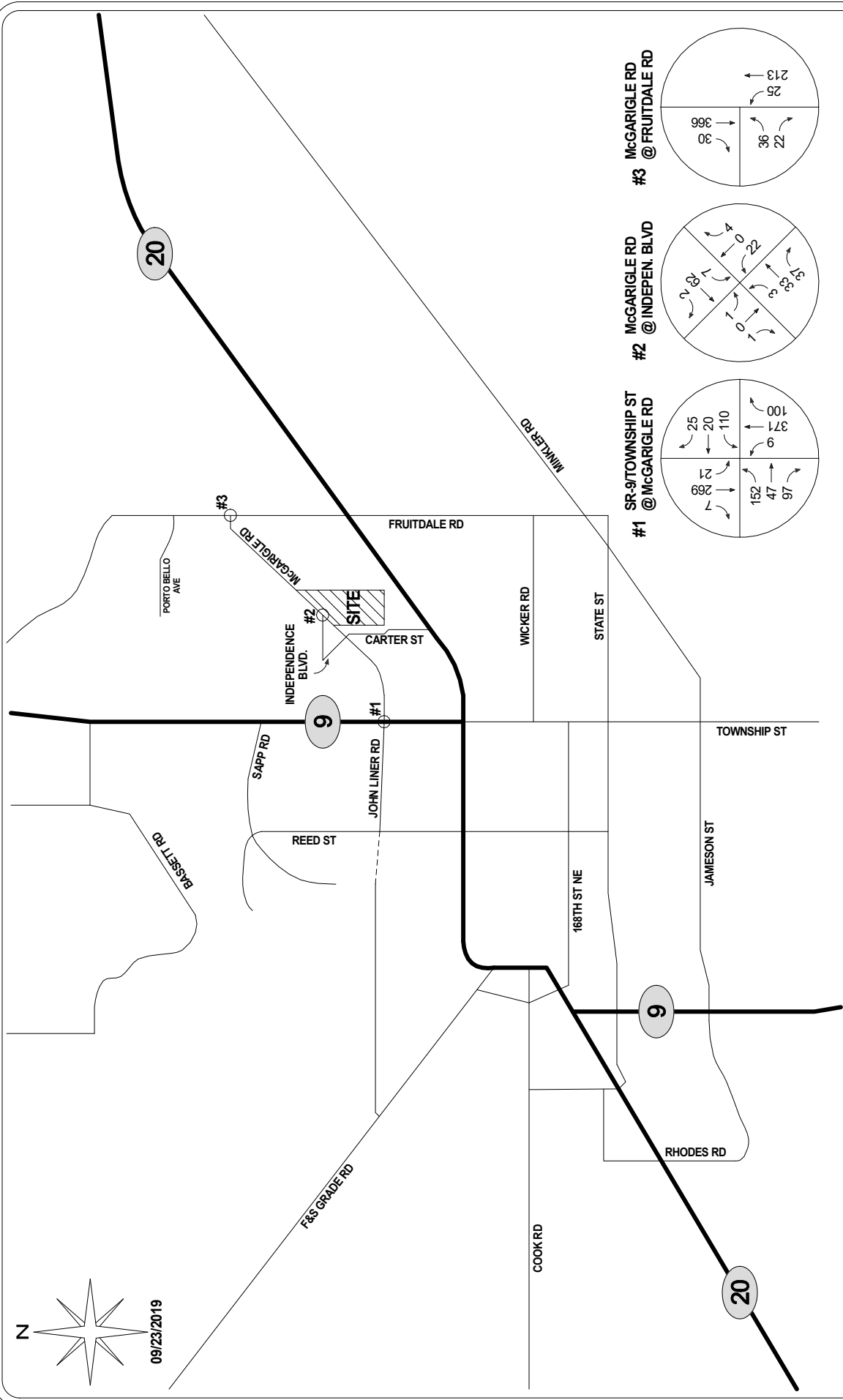
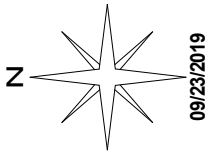

**TRAFFIC IMPACT STUDY**  
GTC #19-229

**GIBSON TRAFFIC CONSULTANTS**

**FIGURE 6**  
2025 FUTURE W/ DEV.  
TURNING MOVEMENTS  
PM PEAK-HOUR

**LEGEND**  
XX → PEAK HOUR TURNING MOVEMENT VOLUMES

**McGARGLE DEVELOPMENT**  
51 NEW DETACHED UNITS  
34 NEW TOWNHOMES  
**CITY OF SEDRO WOOLLEY**

## 4.2 LOS Analysis

The McGarigle development is anticipated to be constructed and occupied by the year 2025. The level of service (LOS) analysis was conducted assuming the development would not have age restricted residential units (unrestricted), which represents the higher of the development's two trip generation scenarios. The 2019 existing, 2025 baseline and 2025 future with development level of service as well as the critical approaches are shown in Table 5.

**Table 5: Intersection LOS Summary – PM Peak-Hour**

Intersection	2019 Existing Conditions			2025 Baseline Conditions			2025 Future with Development Conditions		
	LOS	Delay	Critical Approach	LOS	Delay	Critical Approach	LOS	Delay	Critical Approach
1. SR-9/Township St @ John Liner Rd/McGarigle Rd	C	20.5 sec	Westbound	F	65.5 sec	Eastbound <sup>3</sup>	F	78.0 sec	Eastbound
<i>Single-Lane Roundabout</i>	-	-	-	A	6.9 sec	Northbound (0.42 v/c)	A	7.0 sec	Northbound (0.45 v/c)
2. McGarigle Rd @ Independence Blvd/Access	A	8.6 sec	Eastbound	A	9.1 sec	Eastbound	A	9.8 sec	Westbound
3. McGarigle Rd @ Fruitdale Road	B	10 sec	Eastbound	B	14.3 sec	Eastbound	B	14.4 sec	Eastbound

All study intersections are expected to operate at acceptable levels of service in the 2025 forecast year with planned improvement projects and with the higher trip generation scenario assumed for development trips. Additionally, the single-lane roundabout improvement is expected to operate acceptably at a volume-to-capacity (v/c) ratio below WSDOT's 0.92 threshold. No additional mitigation should therefore be required.

## 5. COLLISION DATA

WSDOT collision data from the five most recent years of collision data (2014-2018) was reviewed at the study intersections. The collision data is summarized in Table 6.

<sup>3</sup> Includes additional eastbound volume from arterial improvements but no intersection improvements



**Table 6: 5-Year Collision Rate Calculation**

<b>Intersection</b>	<b>PM Peak-Hour Intersection Vol.</b>	<b>K-Factor</b>	<b>Total Collisions</b>	<b>Collision Rate<sup>4</sup></b>	<b>Collision Frequency<sup>5</sup></b>
SR-9/Township St @ John Liner Rd/McGarigle Rd	804	10	4	0.27	0.80
McGarigle Rd @ Independence Blvd/Access	67	10	0	0.00	0.00
McGarigle Rd @ Fruitdale Road	277	10	0	0.00	0.00

Reported collisions only occurred at the intersection of SR-9/Township Street and John Liner Rd/McGarigle Rd. A total of four reported collisions occurred at the intersection over the five-year timeline which results in a collision frequency of 0.8 collisions per year. The existing PM peak-hour total intersection volume corresponds to a 5-year collision rate of 0.27 collisions per million entering vehicles. Both the collision frequency and collision rate are below the usual thresholds (5 collisions per year, 1.0 collisions per MEV) for unsignalized intersections where additional safety analysis may be advisable. As a result, there are no further safety recommendations at this time.

## 6. ACCESS ANALYSIS

The development's access to McGarigle Road will be located directly across from Independence Boulevard. McGarigle Road is a two-lane road with a 25-mph posted speed limit. There were no reported collisions along the development site's frontage.

Channelization warrants for left and right-turn channelization were performed based on warrants in WSDOT's 2018 Design Manual. No additional channelization is warranted for the McGarigle development access while assuming the higher unrestricted trip generation volumes. Channelization warrants are included in the attachments.

## 7. TRAFFIC MITIGATION FEES

The City of Sedro Woolley assesses traffic impact fees per PM peak-hour trip. The City's current fee per PM peak-hour trip for development's outside the CBD area is \$2,407. The McGarigle development could have an age-restriction on its units for seniors 55 years and older, or the units could be unrestricted. These two scenarios result in a different trip generation calculation for the development and therefore would have different corresponding traffic impact fees. The age-restricted scenario is expected to generate 24 PM peak-hour trips and would have a corresponding traffic impact fee of \$57,768, equivalent to \$679.62 per unit. The unrestricted scenario is expected to generate 70 PM peak-hour trips and would have a corresponding traffic impact fee of \$168,490, equivalent to \$1,982.24 per unit. The development would pay its proportional share of

<sup>4</sup> The collision rate is based on Million Entering Vehicles.

<sup>5</sup> Collisions per year

improvement projects identified in the level of service analysis by paying the City's standard traffic impact fees because the projects are included in the fee's cost basis.

## 8. CONCLUSIONS

The McGarigle development is an 85-unit residential development that could either be age-restricted for seniors 55 years and older or could have no age restrictions. As an age-restricted development, the McGarigle development would generate approximately 344 average daily trips, 19 AM peak-hour trips, and 24 PM peak-hour trips. As an unrestricted development, the McGarigle development would generate approximately 730 average daily trips, 53 AM peak-hour trips, and 70 PM peak-hour trips. All the intersections analyzed would operate within acceptable level of service standards and the approaches would operate with acceptable delays in 2025 with planned roadway improvements by the City of Sedro Woolley. The development's access would not warrant any additional left or right-turn channelization.

City of Sedro Woolley traffic impact fees would differ depending on whether or not an age restriction was put in place for the units. An age-restricted community would have a proportional traffic impact fee of \$57,768, equivalent to \$679.62 per unit for the 85 total units. An unrestricted community would have a proportional traffic impact fee of \$168,490, equivalent to \$1,982.24 per unit for the 85 total units. Payment of the City's traffic impact fee should be considered the development's proportionate share contribution towards the cost of planned improvement projects because the projects are included in the City's fee cost basis.

# **Trip Generation Calculations**

Trip Generation for: Development Peak Weekday  
 (a.k.a.): Average Weekday Daily Trips (AWDT)

LAND USES	VARIABLE	ITE LU code	Gross Trips				Internal Crossover		NET EXTERNAL TRIPS BY TYPE					
			Trip Rate	% IN	% OUT	In+Out (Total)	% of Gross Trips	Trips In+Out (Total)	IN BOTH DIRECTIONS		DIRECTIONAL ASSIGNMENTS			
									TOTAL	PASS-BY	NEW	PASS-BY	NEW	
Senior Housing Detached	51 units	251	4.27	50%	50%	217.77	0%	0.00	In+Out (Total)	In+Out (Total)	In	Out	In	Out
Senior Housing Attached	34 units	252	3.70	50%	50%	125.80	0%	0.00	In+Out (Total)	In+Out (Total)	In	Out	In	Out
<b>Total</b>						343.57		0.00	343.57	0.00	343.57	0.00	171.79	171.78

McGarigle Development  
 GTC #19-229

**Trip Generation for: Development Peak Weekday, Peak Hour of Adjacent Street Traffic, One Hour between 7 and 9 AM  
 (a.k.a.): Weekday AM Peak Hour**

LAND USES	VARIABLE	ITE LU code	Gross Trips				Internal Crossover		NET EXTERNAL TRIPS BY TYPE					
			Trip Rate	% IN	% OUT	In+Out (Total)	% of Gross Trips	Trips In+Out (Total)	IN BOTH DIRECTIONS		DIRECTIONAL ASSIGNMENTS			
									TOTAL	PASS-BY	NEW	PASS-BY	NEW	
Senior Housing Detached	51 units	251	0.24	33%	67%	12.24	0%	0.00	In+Out (Total)	In+Out (Total)	In	Out	In	Out
Senior Housing Attached	34 units	252	0.20	35%	65%	6.80	0%	0.00	In+Out (Total)	In+Out (Total)	In	Out	In	Out
<b>Total</b>						19.04		0.00	19.04	19.04	0.00	0.00	6.42	12.62

McGarigle Development  
 GTC #19-229

**Trip Generation for: Development Peak Weekday, Peak Hour of Adjacent Street Traffic, One Hour between 4 and 6 PM  
 (a.k.a.): Weekday PM Peak Hour**

LAND USES	VARIABLE	ITE LU code	Gross Trips				Internal Crossover		NET EXTERNAL TRIPS BY TYPE					
			Trip Rate	% IN	% OUT	In+Out (Total)	% of Gross Trips	Trips In+Out (Total)	IN BOTH DIRECTIONS		DIRECTIONAL ASSIGNMENTS			
									TOTAL	PASS-BY	NEW	PASS-BY	NEW	
Senior Housing Detached	51 units	251	0.30	61%	39%	15.30	0%	0.00	In+Out (Total)	In+Out (Total)	In	Out	In	Out
Senior Housing Attached	34 units	252	0.26	55%	45%	8.84	0%	0.00	8.84	8.84	0.00	0.00	4.86	3.98
<b>Total</b>						24.14		0.00	24.14	24.14	0.00	0.00	14.19	9.95

McGarigle Development  
GTC #19-229

AM Peak-Hour

%	New ADT	New AM Peak Hour Trips		
		In	Out	Total
100%	344	6	13	19
1%	3.44	0.06	0.13	0.19
2%	6.87	0.13	0.25	0.38
3%	10.31	0.19	0.38	0.57
4%	13.74	0.26	0.50	0.76
<b>5%</b>	<b>17.18</b>	<b>0.32</b>	<b>0.63</b>	<b>0.95</b>
6%	20.61	0.39	0.76	1.14
7%	24.05	0.45	0.88	1.33
8%	27.49	0.51	1.01	1.52
9%	30.92	0.58	1.14	1.71
<b>10%</b>	<b>34.36</b>	<b>0.64</b>	<b>1.26</b>	<b>1.90</b>
11%	37.79	0.71	1.39	2.09
12%	41.23	0.77	1.51	2.28
13%	44.66	0.83	1.64	2.48
14%	48.10	0.90	1.77	2.67
<b>15%</b>	<b>51.54</b>	<b>0.96</b>	<b>1.89</b>	<b>2.86</b>
16%	54.97	1.03	2.02	3.05
17%	58.41	1.09	2.15	3.24
18%	61.84	1.16	2.27	3.43
19%	65.28	1.22	2.40	3.62
<b>20%</b>	<b>68.71</b>	<b>1.28</b>	<b>2.52</b>	<b>3.81</b>
21%	72.15	1.35	2.65	4.00
22%	75.59	1.41	2.78	4.19
23%	79.02	1.48	2.90	4.38
24%	82.46	1.54	3.03	4.57
<b>25%</b>	<b>85.89</b>	<b>1.61</b>	<b>3.16</b>	<b>4.76</b>
26%	89.33	1.67	3.28	4.95
27%	92.76	1.73	3.41	5.14
28%	96.20	1.80	3.53	5.33
29%	99.64	1.86	3.66	5.52
<b>30%</b>	<b>103.07</b>	<b>1.93</b>	<b>3.79</b>	<b>5.71</b>
31%	106.51	1.99	3.91	5.90
32%	109.94	2.05	4.04	6.09
33%	113.38	2.12	4.16	6.28
34%	116.81	2.18	4.29	6.47
<b>35%</b>	<b>120.25</b>	<b>2.25</b>	<b>4.42</b>	<b>6.66</b>
36%	123.69	2.31	4.54	6.85
37%	127.12	2.38	4.67	7.04
38%	130.56	2.44	4.80	7.24
39%	133.99	2.50	4.92	7.43
<b>40%</b>	<b>137.43</b>	<b>2.57</b>	<b>5.05</b>	<b>7.62</b>
41%	140.86	2.63	5.17	7.81
42%	144.30	2.70	5.30	8.00
43%	147.74	2.76	5.43	8.19
44%	151.17	2.82	5.55	8.38
<b>45%</b>	<b>154.61</b>	<b>2.89</b>	<b>5.68</b>	<b>8.57</b>
46%	158.04	2.95	5.81	8.76
47%	161.48	3.02	5.93	8.95
48%	164.91	3.08	6.06	9.14
49%	168.35	3.15	6.18	9.33
<b>50%</b>	<b>171.79</b>	<b>3.21</b>	<b>6.31</b>	<b>9.52</b>

%	New ADT	New AM Peak Hour Trips		
		In	Out	Total
100%	344	6	13	19
51%	175.22	3.27	6.44	9.71
52%	178.66	3.34	6.56	9.90
53%	182.09	3.40	6.69	10.09
54%	185.53	3.47	6.81	10.28
<b>55%</b>	<b>188.96</b>	<b>3.53</b>	<b>6.94</b>	<b>10.47</b>
56%	192.40	3.60	7.07	10.66
57%	195.83	3.66	7.19	10.85
58%	199.27	3.72	7.32	11.04
59%	202.71	3.79	7.45	11.23
<b>60%</b>	<b>206.14</b>	<b>3.85</b>	<b>7.57</b>	<b>11.42</b>
61%	209.58	3.92	7.70	11.61
62%	213.01	3.98	7.82	11.80
63%	216.45	4.04	7.95	12.00
64%	219.88	4.11	8.08	12.19
<b>65%</b>	<b>223.32</b>	<b>4.17</b>	<b>8.20</b>	<b>12.38</b>
66%	226.76	4.24	8.33	12.57
67%	230.19	4.30	8.46	12.76
68%	233.63	4.37	8.58	12.95
69%	237.06	4.43	8.71	13.14
<b>70%</b>	<b>240.50</b>	<b>4.49</b>	<b>8.83</b>	<b>13.33</b>
71%	243.93	4.56	8.96	13.52
72%	247.37	4.62	9.09	13.71
73%	250.81	4.69	9.21	13.90
74%	254.24	4.75	9.34	14.09
<b>75%</b>	<b>257.68</b>	<b>4.82</b>	<b>9.47</b>	<b>14.28</b>
76%	261.11	4.88	9.59	14.47
77%	264.55	4.94	9.72	14.66
78%	267.98	5.01	9.84	14.85
79%	271.42	5.07	9.97	15.04
<b>80%</b>	<b>274.86</b>	<b>5.14</b>	<b>10.10</b>	<b>15.23</b>
81%	278.29	5.20	10.22	15.42
82%	281.73	5.26	10.35	15.61
83%	285.16	5.33	10.47	15.80
84%	288.60	5.39	10.60	15.99
<b>85%</b>	<b>292.03</b>	<b>5.46</b>	<b>10.73</b>	<b>16.18</b>
86%	295.47	5.52	10.85	16.37
87%	298.91	5.59	10.98	16.56
88%	302.34	5.65	11.11	16.76
89%	305.78	5.71	11.23	16.95
<b>90%</b>	<b>309.21</b>	<b>5.78</b>	<b>11.36</b>	<b>17.14</b>
91%	312.65	5.84	11.48	17.33
92%	316.08	5.91	11.61	17.52
93%	319.52	5.97	11.74	17.71
94%	322.96	6.03	11.86	17.90
<b>95%</b>	<b>326.39</b>	<b>6.10</b>	<b>11.99</b>	<b>18.09</b>
96%	329.83	6.16	12.12	18.28
97%	333.26	6.23	12.24	18.47
98%	336.70	6.29	12.37	18.66
99%	340.13	6.36	12.49	18.85
<b>100%</b>	<b>343.57</b>	<b>6.42</b>	<b>12.62</b>	<b>19.04</b>

McGarigle Development  
GTC #19-229

PM Peak-Hour

%	New ADT	New PM Peak Hour Trips		
		In	Out	Total
100%	344	14	10	24
1%	3.44	0.14	0.10	0.24
2%	6.87	0.28	0.20	0.48
3%	10.31	0.43	0.30	0.72
4%	13.74	0.57	0.40	0.97
<b>5%</b>	<b>17.18</b>	<b>0.71</b>	<b>0.50</b>	<b>1.21</b>
6%	20.61	0.85	0.60	1.45
7%	24.05	0.99	0.70	1.69
8%	27.49	1.14	0.80	1.93
9%	30.92	1.28	0.90	2.17
<b>10%</b>	<b>34.36</b>	<b>1.42</b>	<b>1.00</b>	<b>2.41</b>
11%	37.79	1.56	1.09	2.66
12%	41.23	1.70	1.19	2.90
13%	44.66	1.84	1.29	3.14
14%	48.10	1.99	1.39	3.38
<b>15%</b>	<b>51.54</b>	<b>2.13</b>	<b>1.49</b>	<b>3.62</b>
16%	54.97	2.27	1.59	3.86
17%	58.41	2.41	1.69	4.10
18%	61.84	2.55	1.79	4.35
19%	65.28	2.70	1.89	4.59
<b>20%</b>	<b>68.71</b>	<b>2.84</b>	<b>1.99</b>	<b>4.83</b>
21%	72.15	2.98	2.09	5.07
22%	75.59	3.12	2.19	5.31
23%	79.02	3.26	2.29	5.55
24%	82.46	3.41	2.39	5.79
<b>25%</b>	<b>85.89</b>	<b>3.55</b>	<b>2.49</b>	<b>6.04</b>
26%	89.33	3.69	2.59	6.28
27%	92.76	3.83	2.69	6.52
28%	96.20	3.97	2.79	6.76
29%	99.64	4.12	2.89	7.00
<b>30%</b>	<b>103.07</b>	<b>4.26</b>	<b>2.99</b>	<b>7.24</b>
31%	106.51	4.40	3.08	7.48
32%	109.94	4.54	3.18	7.72
33%	113.38	4.68	3.28	7.97
34%	116.81	4.82	3.38	8.21
<b>35%</b>	<b>120.25</b>	<b>4.97</b>	<b>3.48</b>	<b>8.45</b>
36%	123.69	5.11	3.58	8.69
37%	127.12	5.25	3.68	8.93
38%	130.56	5.39	3.78	9.17
39%	133.99	5.53	3.88	9.41
<b>40%</b>	<b>137.43</b>	<b>5.68</b>	<b>3.98</b>	<b>9.66</b>
41%	140.86	5.82	4.08	9.90
42%	144.30	5.96	4.18	10.14
43%	147.74	6.10	4.28	10.38
44%	151.17	6.24	4.38	10.62
<b>45%</b>	<b>154.61</b>	<b>6.39</b>	<b>4.48</b>	<b>10.86</b>
46%	158.04	6.53	4.58	11.10
47%	161.48	6.67	4.68	11.35
48%	164.91	6.81	4.78	11.59
49%	168.35	6.95	4.88	11.83
<b>50%</b>	<b>171.79</b>	<b>7.10</b>	<b>4.98</b>	<b>12.07</b>

%	New ADT	New PM Peak Hour Trips		
		In	Out	Total
100%	344	14	10	24
51%	175.22	7.24	5.07	12.31
52%	178.66	7.38	5.17	12.55
53%	182.09	7.52	5.27	12.79
54%	185.53	7.66	5.37	13.04
<b>55%</b>	<b>188.96</b>	<b>7.80</b>	<b>5.47</b>	<b>13.28</b>
56%	192.40	7.95	5.57	13.52
57%	195.83	8.09	5.67	13.76
58%	199.27	8.23	5.77	14.00
59%	202.71	8.37	5.87	14.24
<b>60%</b>	<b>206.14</b>	<b>8.51</b>	<b>5.97</b>	<b>14.48</b>
61%	209.58	8.66	6.07	14.73
62%	213.01	8.80	6.17	14.97
63%	216.45	8.94	6.27	15.21
64%	219.88	9.08	6.37	15.45
<b>65%</b>	<b>223.32</b>	<b>9.22</b>	<b>6.47</b>	<b>15.69</b>
66%	226.76	9.37	6.57	15.93
67%	230.19	9.51	6.67	16.17
68%	233.63	9.65	6.77	16.42
69%	237.06	9.79	6.87	16.66
<b>70%</b>	<b>240.50</b>	<b>9.93</b>	<b>6.97</b>	<b>16.90</b>
71%	243.93	10.07	7.06	17.14
72%	247.37	10.22	7.16	17.38
73%	250.81	10.36	7.26	17.62
74%	254.24	10.50	7.36	17.86
<b>75%</b>	<b>257.68</b>	<b>10.64</b>	<b>7.46</b>	<b>18.11</b>
76%	261.11	10.78	7.56	18.35
77%	264.55	10.93	7.66	18.59
78%	267.98	11.07	7.76	18.83
79%	271.42	11.21	7.86	19.07
<b>80%</b>	<b>274.86</b>	<b>11.35</b>	<b>7.96</b>	<b>19.31</b>
81%	278.29	11.49	8.06	19.55
82%	281.73	11.64	8.16	19.79
83%	285.16	11.78	8.26	20.04
84%	288.60	11.92	8.36	20.28
<b>85%</b>	<b>292.03</b>	<b>12.06</b>	<b>8.46</b>	<b>20.52</b>
86%	295.47	12.20	8.56	20.76
87%	298.91	12.35	8.66	21.00
88%	302.34	12.49	8.76	21.24
89%	305.78	12.63	8.86	21.48
<b>90%</b>	<b>309.21</b>	<b>12.77</b>	<b>8.96</b>	<b>21.73</b>
91%	312.65	12.91	9.05	21.97
92%	316.08	13.05	9.15	22.21
93%	319.52	13.20	9.25	22.45
94%	322.96	13.34	9.35	22.69
<b>95%</b>	<b>326.39</b>	<b>13.48</b>	<b>9.45</b>	<b>22.93</b>
96%	329.83	13.62	9.55	23.17
97%	333.26	13.76	9.65	23.42
98%	336.70	13.91	9.75	23.66
99%	340.13	14.05	9.85	23.90
<b>100%</b>	<b>343.57</b>	<b>14.19</b>	<b>9.95</b>	<b>24.14</b>



Trip Generation for: Development Peak Weekday  
 (a.k.a.): Average Weekday Daily Trips (AWDT)

LAND USES	VARIABLE	ITE LU code	Gross Trips				Internal Crossover		NET EXTERNAL TRIPS BY TYPE			
			Trip Rate	% IN	% OUT	In+Out (Total)	% of Gross Trips	Trips In+Out (Total)	IN BOTH DIRECTIONS		DIRECTIONAL ASSIGNMENTS	
									TOTAL	PASS-BY	NEW	PASS-BY
								In+Out (Total)	% of Ext. Trips	In+Out (Total)	In	Out
Single Family Detached	51 units	210	9.44	50%	50%	481.44	0%	0.00	0%	481.44	0.00	240.72
Multifamily Housing (Low-Rise)	34 units	220	7.32	50%	50%	248.88	0%	0.00	0%	248.88	0.00	124.44
<b>Total</b>						730.32		0.00		730.32	0.00	365.16

McGarigle Development  
 GTC #19-229

**Trip Generation for: Development Peak Weekday, Peak Hour of Adjacent Street Traffic, One Hour between 7 and 9 AM  
 (a.k.a.): Weekday AM Peak Hour**

LAND USES	VARIABLE	ITE LU code	Gross Trips				Internal Crossover		NET EXTERNAL TRIPS BY TYPE						
			Trip Rate	% IN	% OUT	In+Out (Total)	% of Gross Trips	Trips In+Out (Total)	IN BOTH DIRECTIONS		DIRECTIONAL ASSIGNMENTS				
									TOTAL	PASS-BY	NEW	PASS-BY	NEW		
Single Family Detached	51 units	210	0.74	25%	75%	37.74	0%	0.00	In+Out (Total)	In+Out (Total)	In	Out	In	Out	
Multifamily Housing (Low-Rise)	34 units	220	0.46	23%	77%	15.64	0%	0.00	37.74	0.00	37.74	0.00	0.00	9.44	28.30
<b>Total</b>						53.38		0.00	53.38	0.00	53.38	0.00	0.00	13.04	40.34

McGarigle Development  
 GTC #19-229

**Trip Generation for: Development Peak Weekday, Peak Hour of Adjacent Street Traffic, One Hour between 4 and 6 PM  
 (a.k.a.): Weekday PM Peak Hour**

LAND USES	VARIABLE	ITE LU code	Gross Trips				Internal Crossover		NET EXTERNAL TRIPS BY TYPE					
			Trip Rate	% IN	% OUT	In+Out (Total)	% of Gross Trips	Trips In+Out (Total)	IN BOTH DIRECTIONS		DIRECTIONAL ASSIGNMENTS			
									TOTAL	PASS-BY	NEW	PASS-BY	NEW	
					In+Out (Total)	% of Ext. Trips	In+Out (Total)	In	Out	In+Out (Total)	In	Out		
Single Family Detached	51 units	210	0.99	63%	37%	50.49	0%	0.00	0.00	50.49	0.00	0.00	31.81	18.68
Multifamily Housing (Low-Rise)	34 units	220	0.56	63%	37%	19.04	0%	0.00	0.00	19.04	0.00	0.00	12.00	7.04
<b>Total</b>						69.53		0.00	0.00	69.53	0.00	0.00	43.81	25.72

McGarigle Development  
GTC #19-229

AM Peak-Hour

%	New ADT	New AM Peak Hour Trips		
		In	Out	Total
100%	730	13	40	53
1%	7.30	0.13	0.40	0.53
2%	14.61	0.26	0.81	1.07
3%	21.91	0.39	1.21	1.60
4%	29.21	0.52	1.61	2.14
<b>5%</b>	<b>36.52</b>	<b>0.65</b>	<b>2.02</b>	<b>2.67</b>
6%	43.82	0.78	2.42	3.20
7%	51.12	0.91	2.82	3.74
8%	58.43	1.04	3.23	4.27
9%	65.73	1.17	3.63	4.80
<b>10%</b>	<b>73.03</b>	<b>1.30</b>	<b>4.03</b>	<b>5.34</b>
11%	80.34	1.43	4.44	5.87
12%	87.64	1.56	4.84	6.41
13%	94.94	1.70	5.24	6.94
14%	102.24	1.83	5.65	7.47
<b>15%</b>	<b>109.55</b>	<b>1.96</b>	<b>6.05</b>	<b>8.01</b>
16%	116.85	2.09	6.45	8.54
17%	124.15	2.22	6.86	9.07
18%	131.46	2.35	7.26	9.61
19%	138.76	2.48	7.66	10.14
<b>20%</b>	<b>146.06</b>	<b>2.61</b>	<b>8.07</b>	<b>10.68</b>
21%	153.37	2.74	8.47	11.21
22%	160.67	2.87	8.87	11.74
23%	167.97	3.00	9.28	12.28
24%	175.28	3.13	9.68	12.81
<b>25%</b>	<b>182.58</b>	<b>3.26</b>	<b>10.09</b>	<b>13.35</b>
26%	189.88	3.39	10.49	13.88
27%	197.19	3.52	10.89	14.41
28%	204.49	3.65	11.30	14.95
29%	211.79	3.78	11.70	15.48
<b>30%</b>	<b>219.10</b>	<b>3.91</b>	<b>12.10</b>	<b>16.01</b>
31%	226.40	4.04	12.51	16.55
32%	233.70	4.17	12.91	17.08
33%	241.01	4.30	13.31	17.62
34%	248.31	4.43	13.72	18.15
<b>35%</b>	<b>255.61</b>	<b>4.56</b>	<b>14.12</b>	<b>18.68</b>
36%	262.92	4.69	14.52	19.22
37%	270.22	4.82	14.93	19.75
38%	277.52	4.96	15.33	20.28
39%	284.82	5.09	15.73	20.82
<b>40%</b>	<b>292.13</b>	<b>5.22</b>	<b>16.14</b>	<b>21.35</b>
41%	299.43	5.35	16.54	21.89
42%	306.73	5.48	16.94	22.42
43%	314.04	5.61	17.35	22.95
44%	321.34	5.74	17.75	23.49
<b>45%</b>	<b>328.64</b>	<b>5.87</b>	<b>18.15</b>	<b>24.02</b>
46%	335.95	6.00	18.56	24.55
47%	343.25	6.13	18.96	25.09
48%	350.55	6.26	19.36	25.62
49%	357.86	6.39	19.77	26.16
<b>50%</b>	<b>365.16</b>	<b>6.52</b>	<b>20.17</b>	<b>26.69</b>

%	New ADT	New AM Peak Hour Trips		
		In	Out	Total
100%	730	13	40	53
51%	372.46	6.65	20.57	27.22
52%	379.77	6.78	20.98	27.76
53%	387.07	6.91	21.38	28.29
54%	394.37	7.04	21.78	28.83
<b>55%</b>	<b>401.68</b>	<b>7.17</b>	<b>22.19</b>	<b>29.36</b>
56%	408.98	7.30	22.59	29.89
57%	416.28	7.43	22.99	30.43
58%	423.59	7.56	23.40	30.96
59%	430.89	7.69	23.80	31.49
<b>60%</b>	<b>438.19</b>	<b>7.82</b>	<b>24.20</b>	<b>32.03</b>
61%	445.50	7.95	24.61	32.56
62%	452.80	8.08	25.01	33.10
63%	460.10	8.22	25.41	33.63
64%	467.40	8.35	25.82	34.16
<b>65%</b>	<b>474.71</b>	<b>8.48</b>	<b>26.22</b>	<b>34.70</b>
66%	482.01	8.61	26.62	35.23
67%	489.31	8.74	27.03	35.76
68%	496.62	8.87	27.43	36.30
69%	503.92	9.00	27.83	36.83
<b>70%</b>	<b>511.22</b>	<b>9.13</b>	<b>28.24</b>	<b>37.37</b>
71%	518.53	9.26	28.64	37.90
72%	525.83	9.39	29.04	38.43
73%	533.13	9.52	29.45	38.97
74%	540.44	9.65	29.85	39.50
<b>75%</b>	<b>547.74</b>	<b>9.78</b>	<b>30.26</b>	<b>40.04</b>
76%	555.04	9.91	30.66	40.57
77%	562.35	10.04	31.06	41.10
78%	569.65	10.17	31.47	41.64
79%	576.95	10.30	31.87	42.17
<b>80%</b>	<b>584.26</b>	<b>10.43</b>	<b>32.27</b>	<b>42.70</b>
81%	591.56	10.56	32.68	43.24
82%	598.86	10.69	33.08	43.77
83%	606.17	10.82	33.48	44.31
84%	613.47	10.95	33.89	44.84
<b>85%</b>	<b>620.77</b>	<b>11.08</b>	<b>34.29</b>	<b>45.37</b>
86%	628.08	11.21	34.69	45.91
87%	635.38	11.34	35.10	46.44
88%	642.68	11.48	35.50	46.97
89%	649.98	11.61	35.90	47.51
<b>90%</b>	<b>657.29</b>	<b>11.74</b>	<b>36.31</b>	<b>48.04</b>
91%	664.59	11.87	36.71	48.58
92%	671.89	12.00	37.11	49.11
93%	679.20	12.13	37.52	49.64
94%	686.50	12.26	37.92	50.18
<b>95%</b>	<b>693.80</b>	<b>12.39</b>	<b>38.32</b>	<b>50.71</b>
96%	701.11	12.52	38.73	51.24
97%	708.41	12.65	39.13	51.78
98%	715.71	12.78	39.53	52.31
99%	723.02	12.91	39.94	52.85
<b>100%</b>	<b>730.32</b>	<b>13.04</b>	<b>40.34</b>	<b>53.38</b>

McGarigle Development  
GTC #19-229

PM Peak-Hour

%	New ADT	New PM Peak Hour Trips		
		In	Out	Total
100%	730	44	26	70
1%	7.30	0.44	0.26	0.70
2%	14.61	0.88	0.51	1.39
3%	21.91	1.31	0.77	2.09
4%	29.21	1.75	1.03	2.78
<b>5%</b>	<b>36.52</b>	<b>2.19</b>	<b>1.29</b>	<b>3.48</b>
6%	43.82	2.63	1.54	4.17
7%	51.12	3.07	1.80	4.87
8%	58.43	3.50	2.06	5.56
9%	65.73	3.94	2.31	6.26
<b>10%</b>	<b>73.03</b>	<b>4.38</b>	<b>2.57</b>	<b>6.95</b>
11%	80.34	4.82	2.83	7.65
12%	87.64	5.26	3.09	8.34
13%	94.94	5.70	3.34	9.04
14%	102.24	6.13	3.60	9.73
<b>15%</b>	<b>109.55</b>	<b>6.57</b>	<b>3.86</b>	<b>10.43</b>
16%	116.85	7.01	4.12	11.12
17%	124.15	7.45	4.37	11.82
18%	131.46	7.89	4.63	12.52
19%	138.76	8.32	4.89	13.21
<b>20%</b>	<b>146.06</b>	<b>8.76</b>	<b>5.14</b>	<b>13.91</b>
21%	153.37	9.20	5.40	14.60
22%	160.67	9.64	5.66	15.30
23%	167.97	10.08	5.92	15.99
24%	175.28	10.51	6.17	16.69
<b>25%</b>	<b>182.58</b>	<b>10.95</b>	<b>6.43</b>	<b>17.38</b>
26%	189.88	11.39	6.69	18.08
27%	197.19	11.83	6.94	18.77
28%	204.49	12.27	7.20	19.47
29%	211.79	12.70	7.46	20.16
<b>30%</b>	<b>219.10</b>	<b>13.14</b>	<b>7.72</b>	<b>20.86</b>
31%	226.40	13.58	7.97	21.55
32%	233.70	14.02	8.23	22.25
33%	241.01	14.46	8.49	22.94
34%	248.31	14.90	8.74	23.64
<b>35%</b>	<b>255.61</b>	<b>15.33</b>	<b>9.00</b>	<b>24.34</b>
36%	262.92	15.77	9.26	25.03
37%	270.22	16.21	9.52	25.73
38%	277.52	16.65	9.77	26.42
39%	284.82	17.09	10.03	27.12
<b>40%</b>	<b>292.13</b>	<b>17.52</b>	<b>10.29</b>	<b>27.81</b>
41%	299.43	17.96	10.55	28.51
42%	306.73	18.40	10.80	29.20
43%	314.04	18.84	11.06	29.90
44%	321.34	19.28	11.32	30.59
<b>45%</b>	<b>328.64</b>	<b>19.71</b>	<b>11.57</b>	<b>31.29</b>
46%	335.95	20.15	11.83	31.98
47%	343.25	20.59	12.09	32.68
48%	350.55	21.03	12.35	33.37
49%	357.86	21.47	12.60	34.07
<b>50%</b>	<b>365.16</b>	<b>21.91</b>	<b>12.86</b>	<b>34.77</b>

%	New ADT	New PM Peak Hour Trips		
		In	Out	Total
100%	730	44	26	70
51%	372.46	22.34	13.12	35.46
52%	379.77	22.78	13.37	36.16
53%	387.07	23.22	13.63	36.85
54%	394.37	23.66	13.89	37.55
<b>55%</b>	<b>401.68</b>	<b>24.10</b>	<b>14.15</b>	<b>38.24</b>
56%	408.98	24.53	14.40	38.94
57%	416.28	24.97	14.66	39.63
58%	423.59	25.41	14.92	40.33
59%	430.89	25.85	15.17	41.02
<b>60%</b>	<b>438.19</b>	<b>26.29</b>	<b>15.43</b>	<b>41.72</b>
61%	445.50	26.72	15.69	42.41
62%	452.80	27.16	15.95	43.11
63%	460.10	27.60	16.20	43.80
64%	467.40	28.04	16.46	44.50
<b>65%</b>	<b>474.71</b>	<b>28.48</b>	<b>16.72</b>	<b>45.19</b>
66%	482.01	28.91	16.98	45.89
67%	489.31	29.35	17.23	46.59
68%	496.62	29.79	17.49	47.28
69%	503.92	30.23	17.75	47.98
<b>70%</b>	<b>511.22</b>	<b>30.67</b>	<b>18.00</b>	<b>48.67</b>
71%	518.53	31.11	18.26	49.37
72%	525.83	31.54	18.52	50.06
73%	533.13	31.98	18.78	50.76
74%	540.44	32.42	19.03	51.45
<b>75%</b>	<b>547.74</b>	<b>32.86</b>	<b>19.29</b>	<b>52.15</b>
76%	555.04	33.30	19.55	52.84
77%	562.35	33.73	19.80	53.54
78%	569.65	34.17	20.06	54.23
79%	576.95	34.61	20.32	54.93
<b>80%</b>	<b>584.26</b>	<b>35.05</b>	<b>20.58</b>	<b>55.62</b>
81%	591.56	35.49	20.83	56.32
82%	598.86	35.92	21.09	57.01
83%	606.17	36.36	21.35	57.71
84%	613.47	36.80	21.60	58.41
<b>85%</b>	<b>620.77</b>	<b>37.24</b>	<b>21.86</b>	<b>59.10</b>
86%	628.08	37.68	22.12	59.80
87%	635.38	38.11	22.38	60.49
88%	642.68	38.55	22.63	61.19
89%	649.98	38.99	22.89	61.88
<b>90%</b>	<b>657.29</b>	<b>39.43</b>	<b>23.15</b>	<b>62.58</b>
91%	664.59	39.87	23.41	63.27
92%	671.89	40.31	23.66	63.97
93%	679.20	40.74	23.92	64.66
94%	686.50	41.18	24.18	65.36
<b>95%</b>	<b>693.80</b>	<b>41.62</b>	<b>24.43</b>	<b>66.05</b>
96%	701.11	42.06	24.69	66.75
97%	708.41	42.50	24.95	67.44
98%	715.71	42.93	25.21	68.14
99%	723.02	43.37	25.46	68.83
<b>100%</b>	<b>730.32</b>	<b>43.81</b>	<b>25.72</b>	<b>69.53</b>

# Turning Movement Counts

**TURNING MOVEMENTS DIAGRAM**

4:00 PM - 6:00 PM PEAK HOUR: 4:00 PM TO 5:00 PM

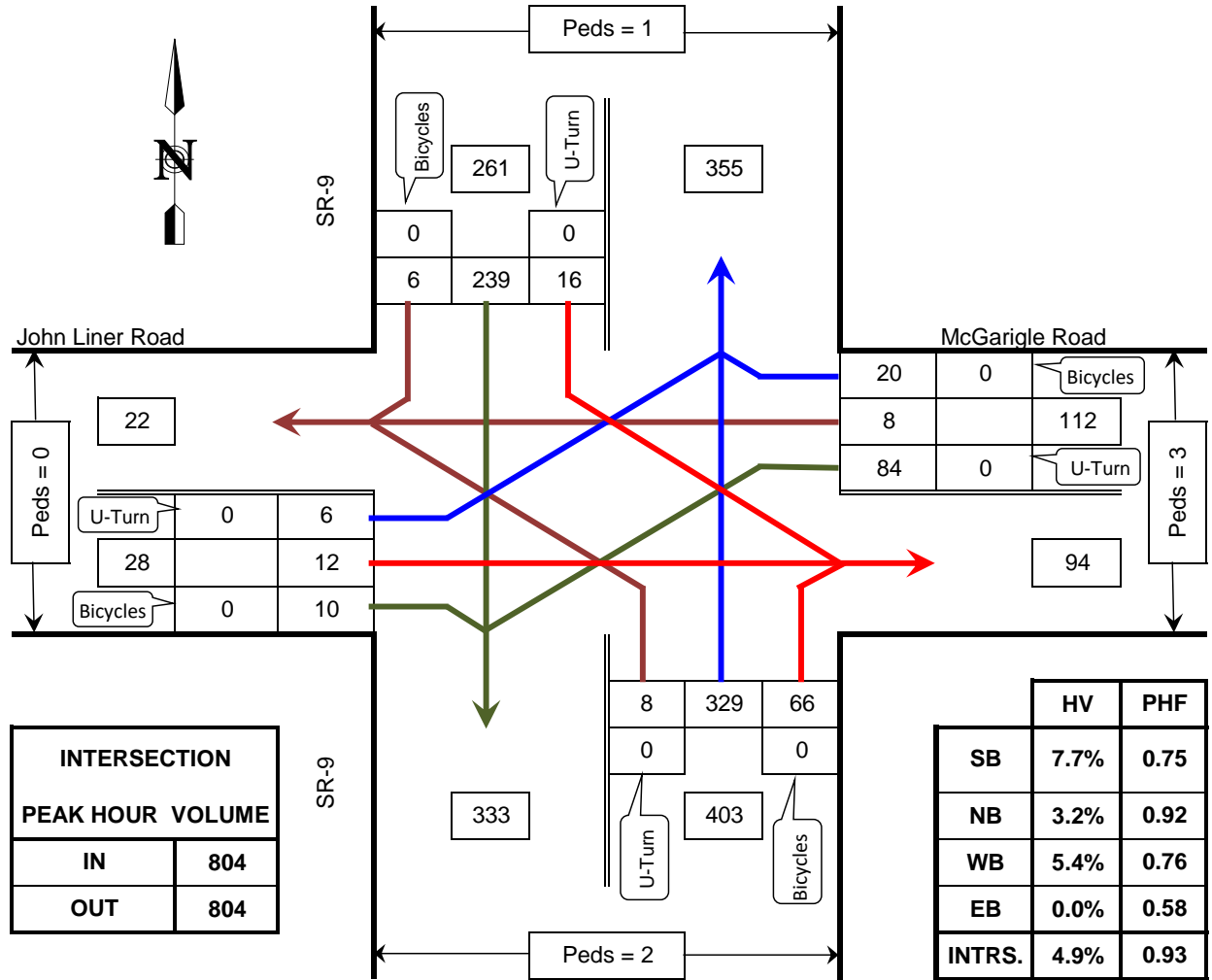

PHF = Peak Hour Factor  
HV = Heavy Vehicle

**John Liner Road/McGarigle Road @ SR-9**

**Sedro Woolley, WA**

COUNTED BY: TDG

DATE OF COUNT: Wed. 4/24/19

REDUCTION DATE: Thu. 4/25/19

TIME OF COUNT: 4:00 PM - 6:00 PM

**TURNING MOVEMENTS DIAGRAM**

**4:00 PM - 6:00 PM PEAK HOUR: 5:00 PM TO 6:00 PM**

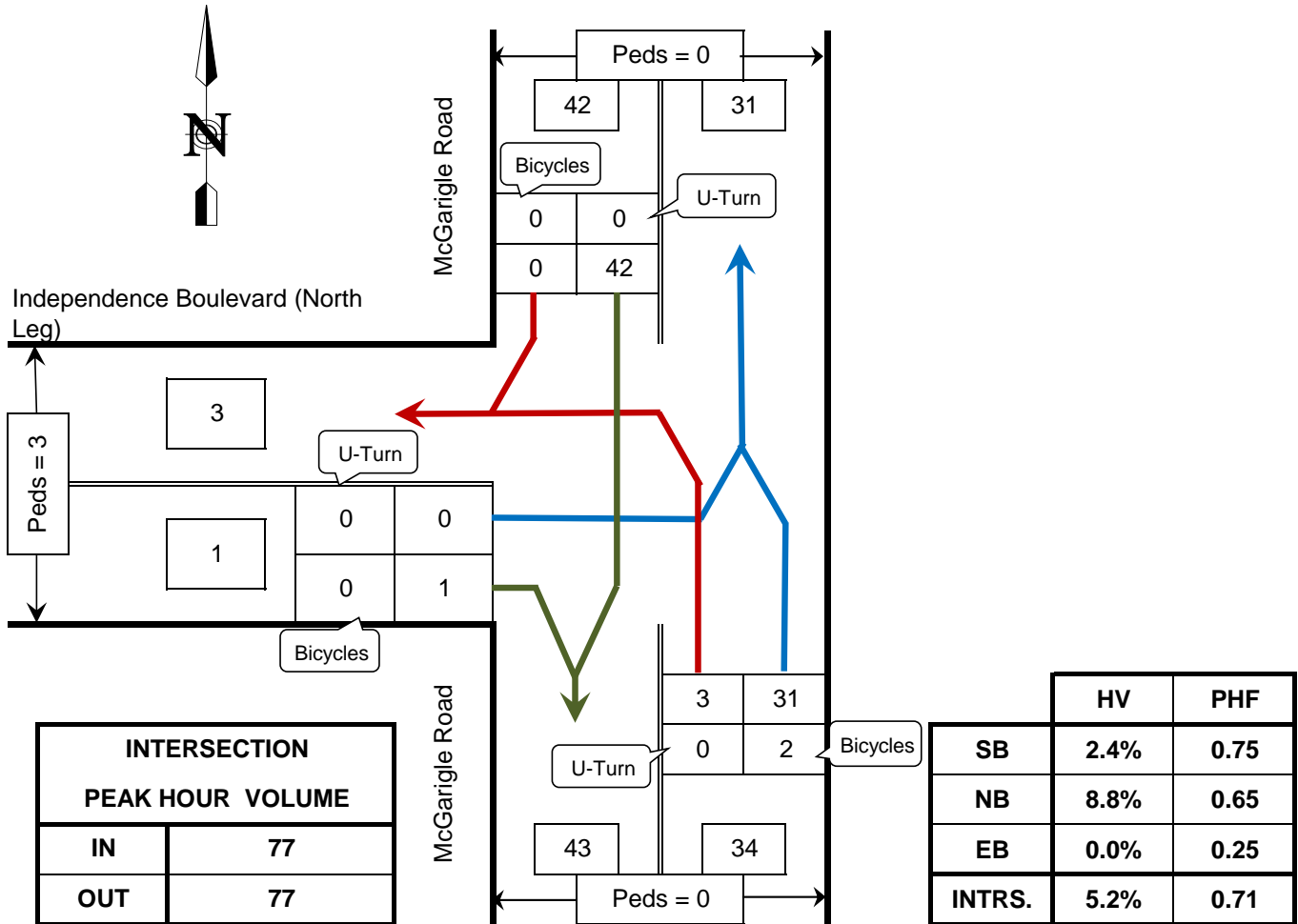

**McGarigle Road @ Independence Boulevard (North Leg)**

**Sedro Woolley, WA**

COUNTED BY: TDG

DATE OF COUNT: Wed. 9/18/19

REDUCTION DATE: Sun. 9/22/19

TIME OF COUNT: 4:00 PM - 6:00 PM



**TURNING MOVEMENTS DIAGRAM**

4:00 PM - 6:00 PM PEAK HOUR: 4:45 PM TO 5:45 PM

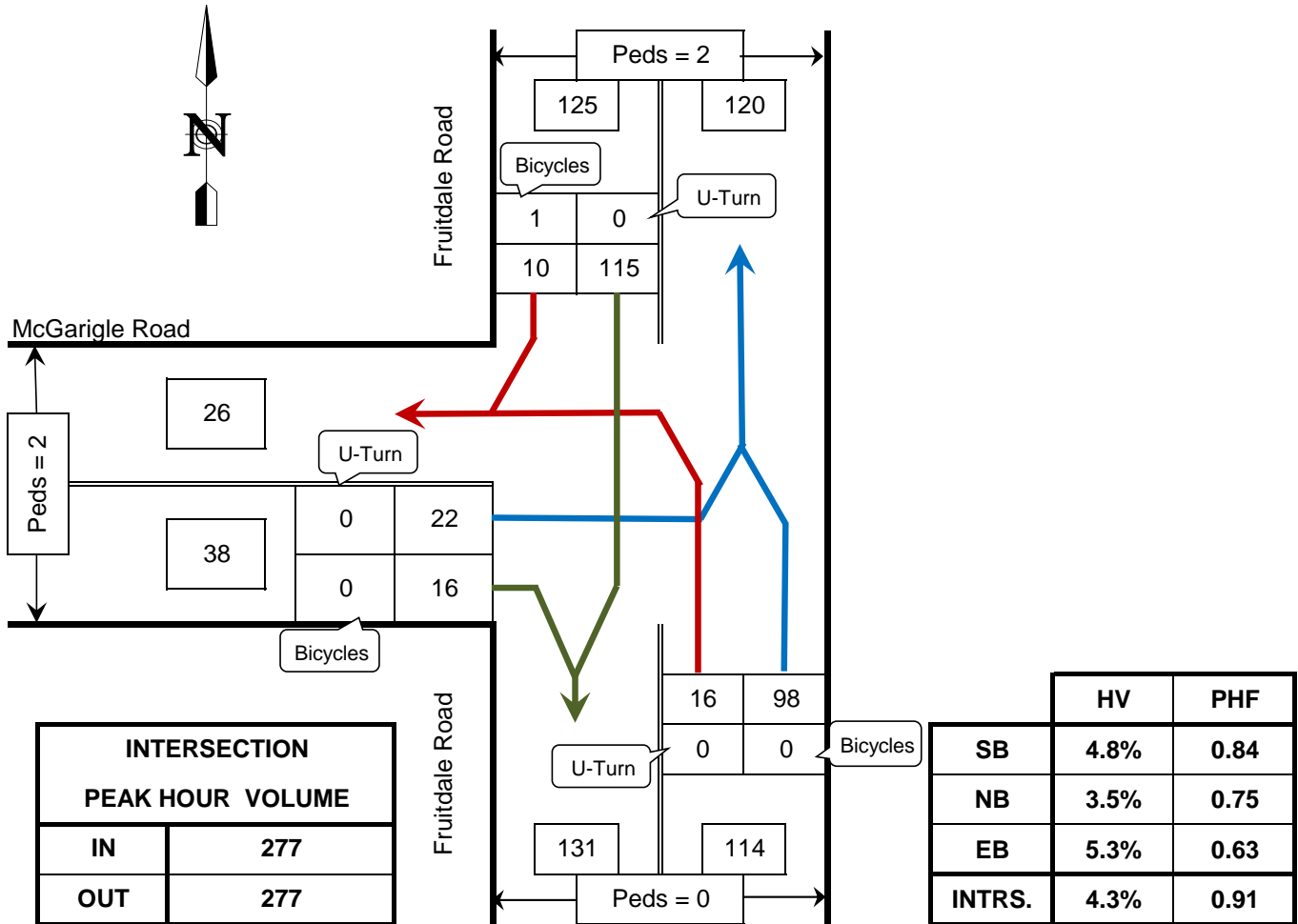

HV = Heavy Vehicles  
PHF = Peak Hour Factor

**McGarigle Road @ Fruitdale Road**

**Sedro Woolley, WA**

COUNTED BY: TDG

DATE OF COUNT: Wed. 4/24/19

REDUCTION DATE: Thu. 4/25/19

TIME OF COUNT: 4:00 PM - 6:00 PM

# **2025 Turning Movement Calculations**

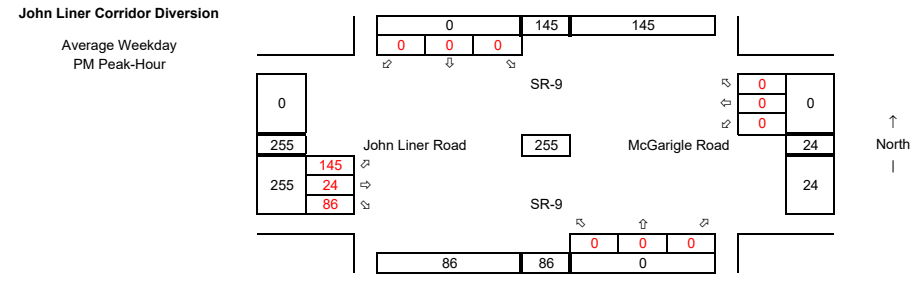
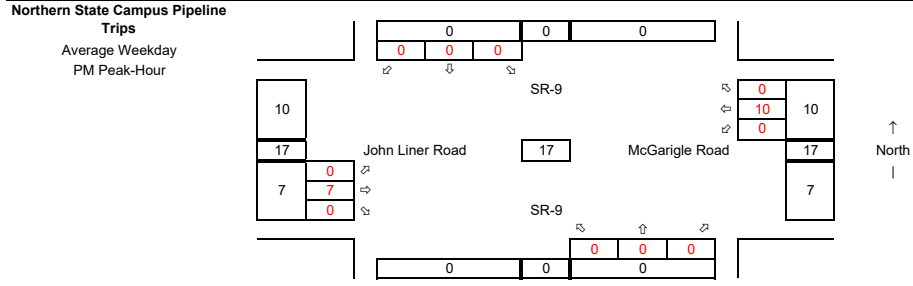
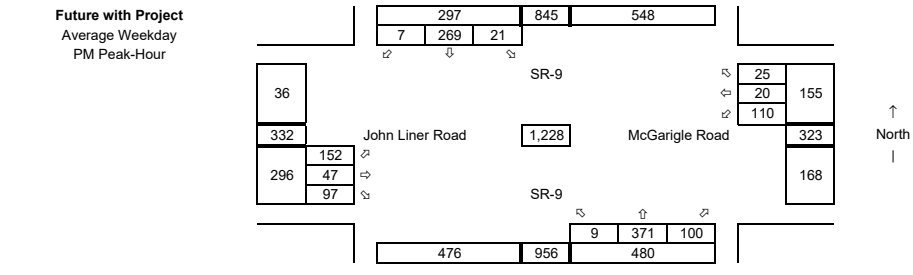
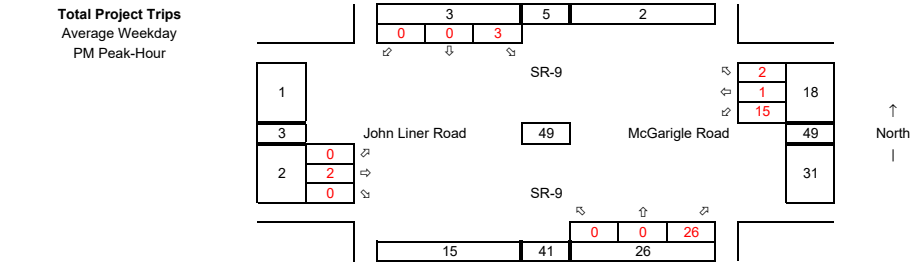
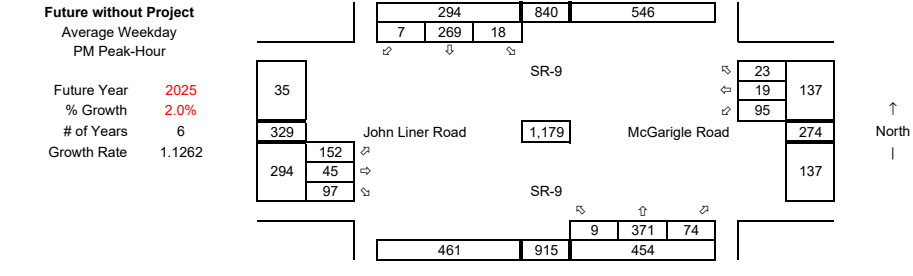
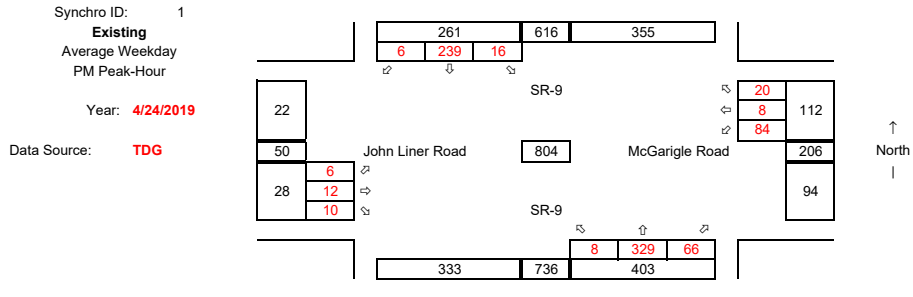

2 McGarigle Rd @ Site Access

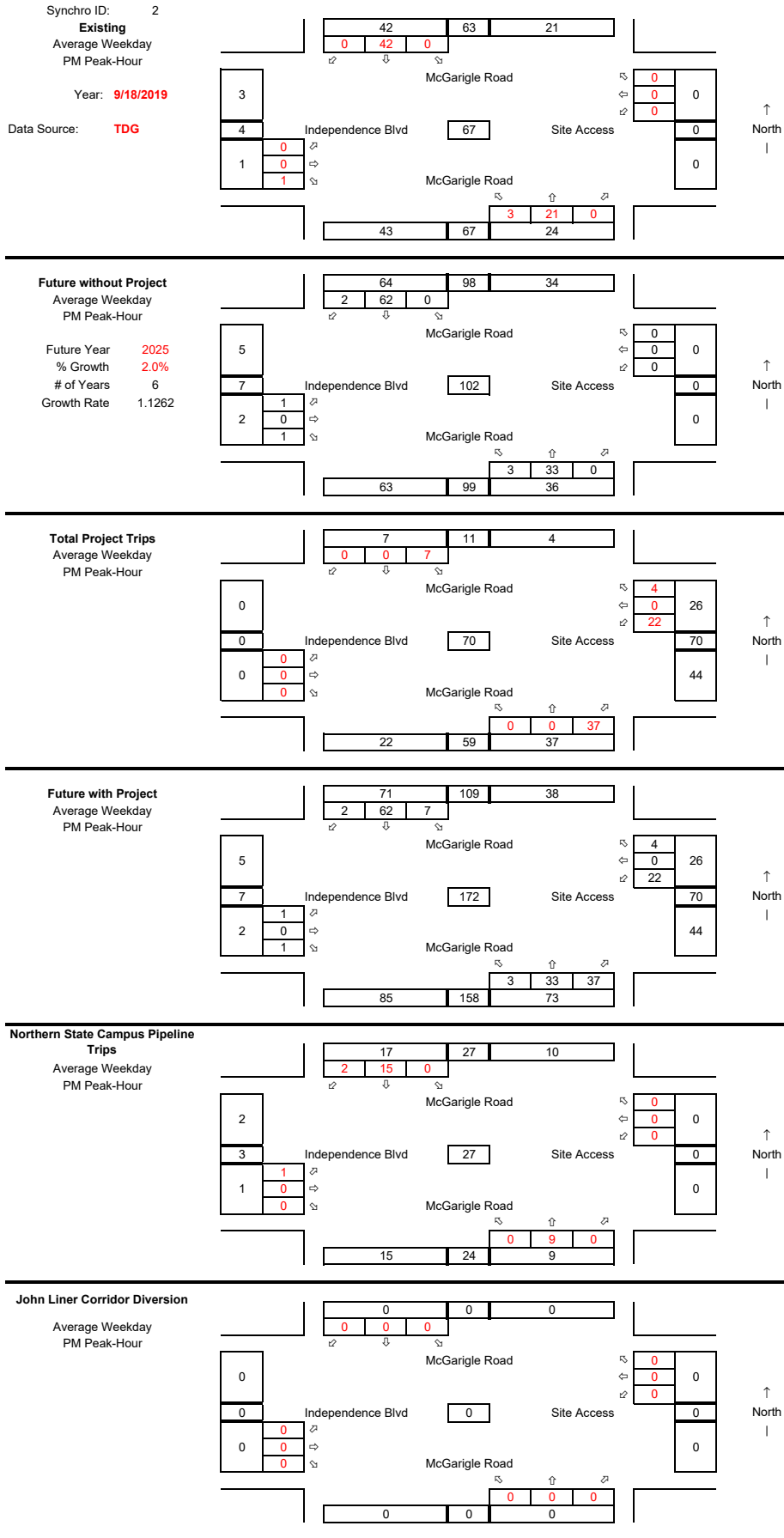

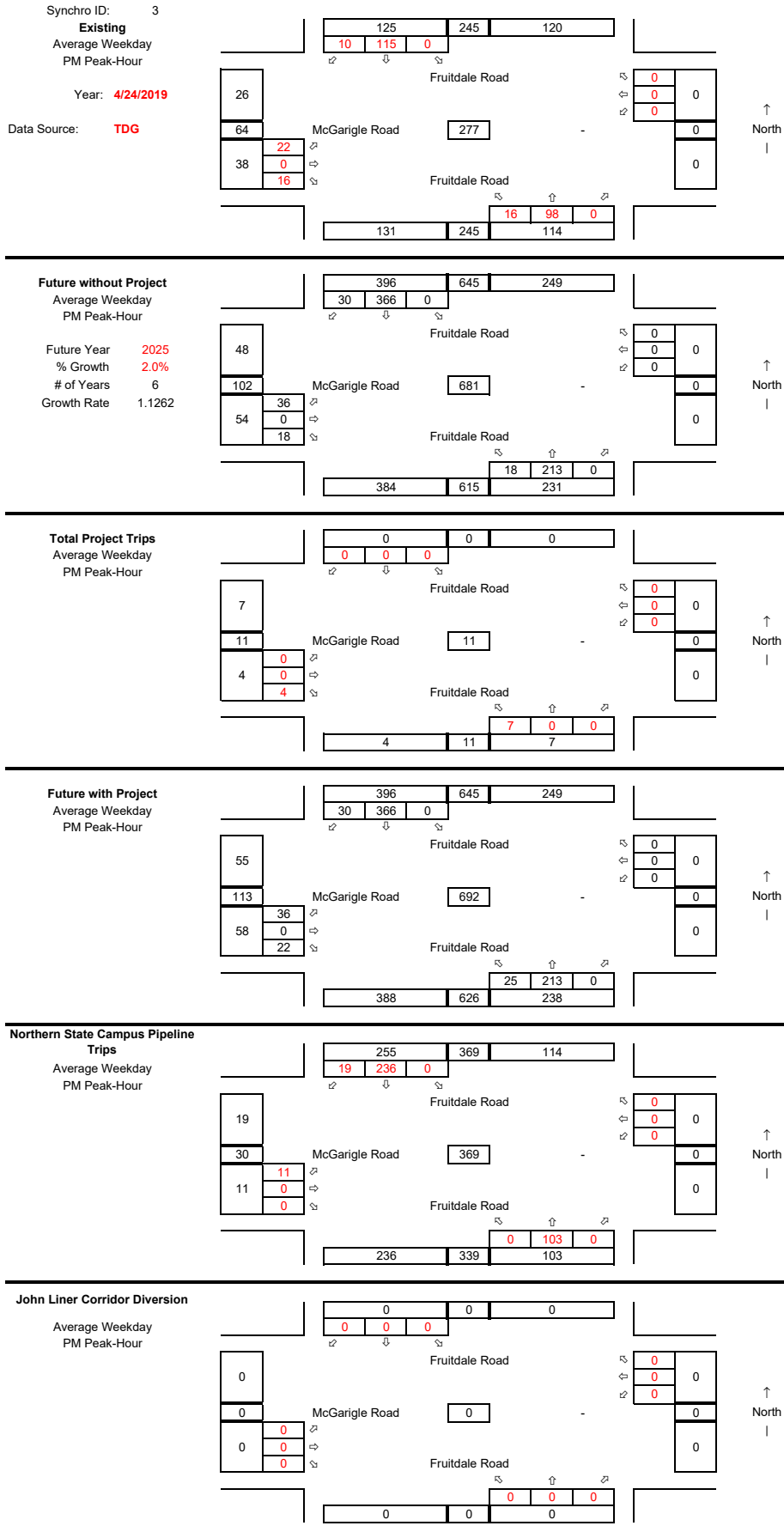

# **Level of Service Calculations**

HCM 6th TWSC  
 1: SR 9 & John Liner Rd/McGarigle Rd

McGarigle Development

Intersection

Int Delay, s/veh	3.6											
Movement	EBL	EBT	EBR	WBL	WBT	WBR	NBL	NBT	NBR	SBL	SBT	SBR
Lane Configurations		↔			↔			↔			↔	
Traffic Vol, veh/h	6	12	10	84	8	20	8	329	66	16	239	6
Future Vol, veh/h	6	12	10	84	8	20	8	329	66	16	239	6
Conflicting Peds, #/hr	1	0	2	2	0	1	0	0	3	3	0	0
Sign Control	Stop	Stop	Stop	Stop	Stop	Stop	Free	Free	Free	Free	Free	Free
RT Channelized	-	-	None	-	-	None	-	-	None	-	-	None
Storage Length	-	-	-	-	-	-	-	-	-	-	-	-
Veh in Median Storage, #	-	0	-	-	0	-	-	0	-	-	0	-
Grade, %	-	0	-	-	0	-	-	0	-	-	0	-
Peak Hour Factor	93	93	93	93	93	93	93	93	93	93	93	93
Heavy Vehicles, %	0	0	0	5	5	5	3	3	3	8	8	8
Mvmt Flow	6	13	11	90	9	22	9	354	71	17	257	6

Major/Minor	Minor2		Minor1			Major1			Major2			
Conflicting Flow All	718	740	262	719	708	394	263	0	0	428	0	0
Stage 1	294	294	-	411	411	-	-	-	-	-	-	-
Stage 2	424	446	-	308	297	-	-	-	-	-	-	-
Critical Hdwy	7.1	6.5	6.2	7.15	6.55	6.25	4.13	-	-	4.18	-	-
Critical Hdwy Stg 1	6.1	5.5	-	6.15	5.55	-	-	-	-	-	-	-
Critical Hdwy Stg 2	6.1	5.5	-	6.15	5.55	-	-	-	-	-	-	-
Follow-up Hdwy	3.5	4	3.3	3.545	4.045	3.345	2.227	-	-	2.272	-	-
Pot Cap-1 Maneuver	347	347	782	340	356	649	1295	-	-	1100	-	-
Stage 1	719	673	-	612	590	-	-	-	-	-	-	-
Stage 2	612	577	-	696	662	-	-	-	-	-	-	-
Platoon blocked, %								-	-	-	-	-
Mov Cap-1 Maneuver	322	337	781	317	345	647	1295	-	-	1097	-	-
Mov Cap-2 Maneuver	322	337	-	317	345	-	-	-	-	-	-	-
Stage 1	713	661	-	605	583	-	-	-	-	-	-	-
Stage 2	577	570	-	660	650	-	-	-	-	-	-	-

Approach	EB		WB			NB			SB		
HCM Control Delay, s	14.3		20.5			0.2			0.5		
HCM LOS	B		C								

Minor Lane/Major Mvmt	NBL	NBT	NBR	EBLn1WBLn1	SBL	SBT	SBR
Capacity (veh/h)	1295	-	-	418	351	1097	-
HCM Lane V/C Ratio	0.007	-	-	0.072	0.343	0.016	-
HCM Control Delay (s)	7.8	0	-	14.3	20.5	8.3	0
HCM Lane LOS	A	A	-	B	C	A	A
HCM 95th %tile Q(veh)	0	-	-	0.2	1.5	0	-

HCM 6th TWSC  
 2: McGarigle Rd & Independence Blvd/Site Access

McGarigle Development

Intersection

Int Delay, s/veh	0.5											
Movement	EBL	EBT	EBR	WBL	WBT	WBR	NBL	NBT	NBR	SBL	SBT	SBR
Lane Configurations		↔			↔			↔			↔	
Traffic Vol, veh/h	0	0	1	0	0	0	3	21	0	0	42	0
Future Vol, veh/h	0	0	1	0	0	0	3	21	0	0	42	0
Conflicting Peds, #/hr	0	0	0	0	0	0	3	0	0	0	0	3
Sign Control	Stop	Stop	Stop	Stop	Stop	Stop	Free	Free	Free	Free	Free	Free
RT Channelized	-	-	None	-	-	None	-	-	None	-	-	None
Storage Length	-	-	-	-	-	-	-	-	-	-	-	-
Veh in Median Storage, #	-	0	-	-	0	-	-	0	-	-	0	-
Grade, %	-	0	-	-	0	-	-	0	-	-	0	-
Peak Hour Factor	71	71	71	71	71	71	71	71	71	71	71	71
Heavy Vehicles, %	0	0	0	2	2	2	9	9	9	2	2	2
Mvmt Flow	0	0	1	0	0	0	4	30	0	0	59	0

Major/Minor	Minor2		Minor1		Major1			Major2				
Conflicting Flow All	100	100	62	98	100	30	62	0	0	30	0	0
Stage 1	62	62	-	38	38	-	-	-	-	-	-	-
Stage 2	38	38	-	60	62	-	-	-	-	-	-	-
Critical Hdwy	7.1	6.5	6.2	7.12	6.52	6.22	4.19	-	-	4.12	-	-
Critical Hdwy Stg 1	6.1	5.5	-	6.12	5.52	-	-	-	-	-	-	-
Critical Hdwy Stg 2	6.1	5.5	-	6.12	5.52	-	-	-	-	-	-	-
Follow-up Hdwy	3.5	4	3.3	3.518	4.018	3.318	2.281	-	-	2.218	-	-
Pot Cap-1 Maneuver	886	794	1009	884	790	1044	1497	-	-	1583	-	-
Stage 1	954	847	-	977	863	-	-	-	-	-	-	-
Stage 2	982	867	-	951	843	-	-	-	-	-	-	-
Platoon blocked, %								-	-	-	-	-
Mov Cap-1 Maneuver	882	789	1006	880	785	1044	1493	-	-	1583	-	-
Mov Cap-2 Maneuver	882	789	-	880	785	-	-	-	-	-	-	-
Stage 1	948	844	-	974	860	-	-	-	-	-	-	-
Stage 2	979	864	-	950	840	-	-	-	-	-	-	-

Approach	EB	WB	NB	SB
HCM Control Delay, s	8.6	0	0.9	0
HCM LOS	A	A		

Minor Lane/Major Mvmt	NBL	NBT	NBR	EBLn1WBLn1	SBL	SBT	SBR
Capacity (veh/h)	1493	-	-	1006	-	1583	-
HCM Lane V/C Ratio	0.003	-	-	0.001	-	-	-
HCM Control Delay (s)	7.4	0	-	8.6	0	0	-
HCM Lane LOS	A	A	-	A	A	A	-
HCM 95th %tile Q(veh)	0	-	-	0	-	0	-



HCM 6th TWSC  
3: Fruitdale Rd & McGarigle Rd

McGarigle Development

Intersection

Int Delay, s/veh 1.8

Movement	EBL	EBR	NBL	NBT	SBT	SBR
Lane Configurations						
Traffic Vol, veh/h	22	16	16	98	115	10
Future Vol, veh/h	22	16	16	98	115	10
Conflicting Peds, #/hr	2	0	2	0	0	2
Sign Control	Stop	Stop	Free	Free	Free	Free
RT Channelized	-	None	-	None	-	None
Storage Length	0	-	-	-	-	-
Veh in Median Storage, #	0	-	-	0	0	-
Grade, %	0	-	-	0	0	-
Peak Hour Factor	91	91	91	91	91	91
Heavy Vehicles, %	5	5	4	4	5	5
Mvmt Flow	24	18	18	108	126	11

Major/Minor	Minor2	Major1	Major2			
Conflicting Flow All	280	134	139	0	-	0
Stage 1	134	-	-	-	-	-
Stage 2	146	-	-	-	-	-
Critical Hdwy	6.45	6.25	4.14	-	-	-
Critical Hdwy Stg 1	5.45	-	-	-	-	-
Critical Hdwy Stg 2	5.45	-	-	-	-	-
Follow-up Hdwy	3.545	3.345	2.236	-	-	-
Pot Cap-1 Maneuver	704	907	1432	-	-	-
Stage 1	885	-	-	-	-	-
Stage 2	874	-	-	-	-	-
Platoon blocked, %				-	-	-
Mov Cap-1 Maneuver	692	905	1429	-	-	-
Mov Cap-2 Maneuver	692	-	-	-	-	-
Stage 1	872	-	-	-	-	-
Stage 2	872	-	-	-	-	-

Approach	EB	NB	SB
HCM Control Delay, s	10	1.1	0
HCM LOS	B		

Minor Lane/Major Mvmt	NBL	NBT	EBLn1	SBT	SBR
Capacity (veh/h)	1429	-	768	-	-
HCM Lane V/C Ratio	0.012	-	0.054	-	-
HCM Control Delay (s)	7.6	0	10	-	-
HCM Lane LOS	A	A	B	-	-
HCM 95th %tile Q(veh)	0	-	0.2	-	-

HCM 6th TWSC  
 1: SR 9 & John Liner Rd/McGarigle Rd

McGarigle Development

Intersection

Int Delay, s/veh	21.6											
Movement	EBL	EBT	EBR	WBL	WBT	WBR	NBL	NBT	NBR	SBL	SBT	SBR
Lane Configurations		↔			↔			↔			↔	
Traffic Vol, veh/h	152	45	97	95	19	23	9	371	74	18	269	7
Future Vol, veh/h	152	45	97	95	19	23	9	371	74	18	269	7
Conflicting Peds, #/hr	1	0	2	2	0	1	0	0	3	3	0	0
Sign Control	Stop	Stop	Stop	Stop	Stop	Stop	Free	Free	Free	Free	Free	Free
RT Channelized	-	-	None	-	-	None	-	-	None	-	-	None
Storage Length	-	-	-	-	-	-	-	-	-	-	-	-
Veh in Median Storage, #	-	0	-	-	0	-	-	0	-	-	0	-
Grade, %	-	0	-	-	0	-	-	0	-	-	0	-
Peak Hour Factor	93	93	93	93	93	93	93	93	93	93	93	93
Heavy Vehicles, %	0	0	0	5	5	5	3	3	3	8	8	8
Mvmt Flow	163	48	104	102	20	25	10	399	80	19	289	8

Major/Minor	Minor2		Minor1		Major1			Major2				
Conflicting Flow All	814	833	295	871	797	443	297	0	0	482	0	0
Stage 1	331	331	-	462	462	-	-	-	-	-	-	-
Stage 2	483	502	-	409	335	-	-	-	-	-	-	-
Critical Hdwy	7.1	6.5	6.2	7.15	6.55	6.25	4.13	-	-	4.18	-	-
Critical Hdwy Stg 1	6.1	5.5	-	6.15	5.55	-	-	-	-	-	-	-
Critical Hdwy Stg 2	6.1	5.5	-	6.15	5.55	-	-	-	-	-	-	-
Follow-up Hdwy	3.5	4	3.3	3.545	4.045	3.345	2.227	-	-	2.272	-	-
Pot Cap-1 Maneuver	299	307	749	268	316	608	1259	-	-	1050	-	-
Stage 1	687	649	-	574	560	-	-	-	-	-	-	-
Stage 2	569	545	-	613	637	-	-	-	-	-	-	-
Platoon blocked, %								-	-	-	-	-
Mov Cap-1 Maneuver	265	296	748	196	305	606	1259	-	-	1047	-	-
Mov Cap-2 Maneuver	265	296	-	196	305	-	-	-	-	-	-	-
Stage 1	679	635	-	566	552	-	-	-	-	-	-	-
Stage 2	519	537	-	476	623	-	-	-	-	-	-	-

Approach	EB		WB		NB			SB		
HCM Control Delay, s	65.5		43.4		0.2			0.5		
HCM LOS	F		E							

Minor Lane/Major Mvmt	NBL	NBT	NBR	EBLn1WBLn1	SBL	SBT	SBR
Capacity (veh/h)	1259	-	-	344	234	1047	-
HCM Lane V/C Ratio	0.008	-	-	0.919	0.63	0.018	-
HCM Control Delay (s)	7.9	0	-	65.5	43.4	8.5	0
HCM Lane LOS	A	A	-	F	E	A	A
HCM 95th %tile Q(veh)	0	-	-	9.3	3.8	0.1	-

# MOVEMENT SUMMARY

 Site: 1 [SR-9 at John Liner Rd 2025 Baseline]

2025 Baseline  
PM Peak-Hour  
Site Category: (None)  
Roundabout

Movement Performance - Vehicles												
Mov ID	Turn	Demand Total veh/h	Flows HV %	Deg. Satn v/c	Average Delay sec	Level of Service	95% Back Vehicles veh	Queue Distance ft	Prop. Queued	Effective Stop Rate	Aver. No. Cycles	Average Speed mph
South: SR-9 (NB)												
3	L2	10	3.0	0.424	11.0	LOS B	2.8	72.5	0.52	0.55	0.52	36.0
8	T1	399	3.0	0.424	5.3	LOS A	2.8	72.5	0.52	0.55	0.52	36.0
18	R2	80	3.0	0.424	5.4	LOS A	2.8	72.5	0.52	0.55	0.52	35.0
Approach		488	3.0	0.424	5.4	LOS A	2.8	72.5	0.52	0.55	0.52	35.9
East: John Liner Rd (WB)												
1	L2	102	5.0	0.167	12.5	LOS B	0.9	24.2	0.62	0.75	0.62	33.9
6	T1	20	5.0	0.167	6.9	LOS A	0.9	24.2	0.62	0.75	0.62	34.0
16	R2	25	5.0	0.167	6.9	LOS A	0.9	24.2	0.62	0.75	0.62	33.1
Approach		147	5.0	0.167	10.8	LOS B	0.9	24.2	0.62	0.75	0.62	33.8
North: SR-9 (SB)												
7	L2	19	8.0	0.268	10.4	LOS B	1.6	41.4	0.35	0.47	0.35	36.2
4	T1	289	8.0	0.268	4.7	LOS A	1.6	41.4	0.35	0.47	0.35	36.3
14	R2	8	8.0	0.268	4.8	LOS A	1.6	41.4	0.35	0.47	0.35	35.2
Approach		316	8.0	0.268	5.0	LOS A	1.6	41.4	0.35	0.47	0.35	36.3
West: John Liner Rd (EB)												
5	L2	163	5.0	0.316	11.9	LOS B	1.8	47.2	0.58	0.72	0.58	34.7
2	T1	48	5.0	0.316	6.3	LOS A	1.8	47.2	0.58	0.72	0.58	34.7
12	R2	104	5.0	0.316	6.3	LOS A	1.8	47.2	0.58	0.72	0.58	33.7
Approach		316	5.0	0.316	9.2	LOS A	1.8	47.2	0.58	0.72	0.58	34.4
All Vehicles		1268	5.0	0.424	6.9	LOS A	2.8	72.5	0.50	0.60	0.50	35.3

Site Level of Service (LOS) Method: Delay & Degree of Saturation (SIDRA). Site LOS Method is specified in the Parameter Settings dialog (Site tab).

Roundabout LOS Method: Same as Signalised Intersections.

Vehicle movement LOS values are based on average delay and v/c ratio (degree of saturation) per movement.

Intersection and Approach LOS values are based on average delay for all movements (v/c not used).

Roundabout Capacity Model: SIDRA Standard.

SIDRA Standard Delay Model is used. Control Delay includes Geometric Delay.

Gap-Acceptance Capacity: SIDRA Standard (Akçelik M3D).

HV (%) values are calculated for All Movement Classes of All Heavy Vehicle Model Designation.

HCM 6th TWSC  
2: McGarigle Rd & Independence Blvd/Site Access

McGarigle Development

Intersection

Int Delay, s/veh	0.4											
Movement	EBL	EBT	EBR	WBL	WBT	WBR	NBL	NBT	NBR	SBL	SBT	SBR
Lane Configurations		↔			↔			↔			↔	
Traffic Vol, veh/h	1	0	1	0	0	0	3	33	0	0	62	2
Future Vol, veh/h	1	0	1	0	0	0	3	33	0	0	62	2
Conflicting Peds, #/hr	0	0	0	0	0	0	3	0	0	0	0	3
Sign Control	Stop	Stop	Stop	Stop	Stop	Stop	Free	Free	Free	Free	Free	Free
RT Channelized	-	-	None	-	-	None	-	-	None	-	-	None
Storage Length	-	-	-	-	-	-	-	-	-	-	-	-
Veh in Median Storage, #	-	0	-	-	0	-	-	0	-	-	0	-
Grade, %	-	0	-	-	0	-	-	0	-	-	0	-
Peak Hour Factor	71	71	71	71	71	71	71	71	71	71	71	71
Heavy Vehicles, %	0	0	0	2	2	2	9	9	9	2	2	2
Mvmt Flow	1	0	1	0	0	0	4	46	0	0	87	3

Major/Minor	Minor2		Minor1		Major1			Major2				
Conflicting Flow All	146	146	92	143	147	46	93	0	0	46	0	0
Stage 1	92	92	-	54	54	-	-	-	-	-	-	-
Stage 2	54	54	-	89	93	-	-	-	-	-	-	-
Critical Hdwy	7.1	6.5	6.2	7.12	6.52	6.22	4.19	-	-	4.12	-	-
Critical Hdwy Stg 1	6.1	5.5	-	6.12	5.52	-	-	-	-	-	-	-
Critical Hdwy Stg 2	6.1	5.5	-	6.12	5.52	-	-	-	-	-	-	-
Follow-up Hdwy	3.5	4	3.3	3.518	4.018	3.318	2.281	-	-	2.218	-	-
Pot Cap-1 Maneuver	827	749	971	826	744	1023	1458	-	-	1562	-	-
Stage 1	920	823	-	958	850	-	-	-	-	-	-	-
Stage 2	963	854	-	918	818	-	-	-	-	-	-	-
Platoon blocked, %								-	-	-	-	-
Mov Cap-1 Maneuver	823	745	968	823	740	1023	1454	-	-	1562	-	-
Mov Cap-2 Maneuver	823	745	-	823	740	-	-	-	-	-	-	-
Stage 1	914	821	-	955	847	-	-	-	-	-	-	-
Stage 2	960	851	-	917	816	-	-	-	-	-	-	-

Approach	EB	WB	NB	SB
HCM Control Delay, s	9.1	0	0.6	0
HCM LOS	A	A		

Minor Lane/Major Mvmt	NBL	NBT	NBR	EBLn1WBLn1	SBL	SBT	SBR
Capacity (veh/h)	1454	-	-	890	-	1562	-
HCM Lane V/C Ratio	0.003	-	-	0.003	-	-	-
HCM Control Delay (s)	7.5	0	-	9.1	0	0	-
HCM Lane LOS	A	A	-	A	A	A	-
HCM 95th %tile Q(veh)	0	-	-	0	-	0	-

HCM 6th TWSC  
3: Fruitdale Rd & McGarigle Rd

McGarigle Development

Intersection

Int Delay, s/veh	1.3					
Movement	EBL	EBR	NBL	NBT	SBT	SBR
Lane Configurations						
Traffic Vol, veh/h	36	18	18	213	366	30
Future Vol, veh/h	36	18	18	213	366	30
Conflicting Peds, #/hr	2	0	2	0	0	2
Sign Control	Stop	Stop	Free	Free	Free	Free
RT Channelized	-	None	-	None	-	None
Storage Length	0	-	-	-	-	-
Veh in Median Storage, #	0	-	-	0	0	-
Grade, %	0	-	-	0	0	-
Peak Hour Factor	91	91	91	91	91	91
Heavy Vehicles, %	5	5	4	4	5	5
Mvmt Flow	40	20	20	234	402	33

Major/Minor	Minor2	Major1		Major2	
Conflicting Flow All	697	421	437	0	0
Stage 1	421	-	-	-	-
Stage 2	276	-	-	-	-
Critical Hdwy	6.45	6.25	4.14	-	-
Critical Hdwy Stg 1	5.45	-	-	-	-
Critical Hdwy Stg 2	5.45	-	-	-	-
Follow-up Hdwy	3.545	3.345	2.236	-	-
Pot Cap-1 Maneuver	403	626	1112	-	-
Stage 1	656	-	-	-	-
Stage 2	764	-	-	-	-
Platoon blocked, %				-	-
Mov Cap-1 Maneuver	393	625	1110	-	-
Mov Cap-2 Maneuver	393	-	-	-	-
Stage 1	641	-	-	-	-
Stage 2	762	-	-	-	-

Approach	EB	NB	SB
HCM Control Delay, s	14.3	0.6	0
HCM LOS	B		

Minor Lane/Major Mvmt	NBL	NBT	EBLn1	SBT	SBR
Capacity (veh/h)	1110	-	448	-	-
HCM Lane V/C Ratio	0.018	-	0.132	-	-
HCM Control Delay (s)	8.3	0	14.3	-	-
HCM Lane LOS	A	A	B	-	-
HCM 95th %tile Q(veh)	0.1	-	0.5	-	-

HCM 6th TWSC  
 1: SR 9 & John Liner Rd/McGarigle Rd

McGarigle Development

Intersection

Int Delay, s/veh	26.5											
Movement	EBL	EBT	EBR	WBL	WBT	WBR	NBL	NBT	NBR	SBL	SBT	SBR
Lane Configurations		↔			↔			↔			↔	
Traffic Vol, veh/h	152	47	97	110	20	25	9	371	100	21	269	7
Future Vol, veh/h	152	47	97	110	20	25	9	371	100	21	269	7
Conflicting Peds, #/hr	1	0	2	2	0	1	0	0	3	3	0	0
Sign Control	Stop	Stop	Stop	Stop	Stop	Stop	Free	Free	Free	Free	Free	Free
RT Channelized	-	-	None	-	-	None	-	-	None	-	-	None
Storage Length	-	-	-	-	-	-	-	-	-	-	-	-
Veh in Median Storage, #	-	0	-	-	0	-	-	0	-	-	0	-
Grade, %	-	0	-	-	0	-	-	0	-	-	0	-
Peak Hour Factor	93	93	93	93	93	93	93	93	93	93	93	93
Heavy Vehicles, %	0	0	0	5	5	5	3	3	3	8	8	8
Mvmt Flow	163	51	104	118	22	27	10	399	108	23	289	8

Major/Minor	Minor2		Minor1			Major1			Major2			
Conflicting Flow All	838	869	295	895	819	457	297	0	0	510	0	0
Stage 1	339	339	-	476	476	-	-	-	-	-	-	-
Stage 2	499	530	-	419	343	-	-	-	-	-	-	-
Critical Hdwy	7.1	6.5	6.2	7.15	6.55	6.25	4.13	-	-	4.18	-	-
Critical Hdwy Stg 1	6.1	5.5	-	6.15	5.55	-	-	-	-	-	-	-
Critical Hdwy Stg 2	6.1	5.5	-	6.15	5.55	-	-	-	-	-	-	-
Follow-up Hdwy	3.5	4	3.3	3.545	4.045	3.345	2.227	-	-	2.272	-	-
Pot Cap-1 Maneuver	288	292	749	258	307	597	1259	-	-	1025	-	-
Stage 1	680	643	-	564	552	-	-	-	-	-	-	-
Stage 2	557	530	-	606	632	-	-	-	-	-	-	-
Platoon blocked, %								-	-	-	-	-
Mov Cap-1 Maneuver	252	280	748	185	294	595	1259	-	-	1022	-	-
Mov Cap-2 Maneuver	252	280	-	185	294	-	-	-	-	-	-	-
Stage 1	673	626	-	556	544	-	-	-	-	-	-	-
Stage 2	505	523	-	466	615	-	-	-	-	-	-	-

Approach	EB		WB			NB			SB		
HCM Control Delay, s	78		59.3			0.1			0.6		
HCM LOS	F		F								

Minor Lane/Major Mvmt	NBL	NBT	NBR	EBLn1	WBLn1	SBL	SBT	SBR
Capacity (veh/h)	1259	-	-	329	220	1022	-	-
HCM Lane V/C Ratio	0.008	-	-	0.967	0.758	0.022	-	-
HCM Control Delay (s)	7.9	0	-	78	59.3	8.6	0	-
HCM Lane LOS	A	A	-	F	F	A	A	-
HCM 95th %tile Q(veh)	0	-	-	10.3	5.2	0.1	-	-

# MOVEMENT SUMMARY

 Site: 1 [SR-9 at John Liner Rd 2025 Future With]

2025 Future With  
PM Peak-Hour  
Site Category: (None)  
Roundabout

Movement Performance - Vehicles												
Mov ID	Turn	Demand Total veh/h	Flows HV %	Deg. Satn v/c	Average Delay sec	Level of Service	95% Back Vehicles veh	Queue Distance ft	Prop. Queued	Effective Stop Rate	Aver. No. Cycles	Average Speed mph
South: SR-9 (NB)												
3	L2	10	3.0	0.450	11.0	LOS B	3.1	79.2	0.54	0.56	0.54	36.0
8	T1	399	3.0	0.450	5.4	LOS A	3.1	79.2	0.54	0.56	0.54	36.0
18	R2	108	3.0	0.450	5.4	LOS A	3.1	79.2	0.54	0.56	0.54	35.0
Approach		516	3.0	0.450	5.5	LOS A	3.1	79.2	0.54	0.56	0.54	35.8
East: John Liner Rd (WB)												
1	L2	118	5.0	0.189	12.6	LOS B	1.1	27.9	0.63	0.76	0.63	33.9
6	T1	22	5.0	0.189	6.9	LOS A	1.1	27.9	0.63	0.76	0.63	33.9
16	R2	27	5.0	0.189	7.0	LOS A	1.1	27.9	0.63	0.76	0.63	33.0
Approach		167	5.0	0.189	10.9	LOS B	1.1	27.9	0.63	0.76	0.63	33.7
North: SR-9 (SB)												
7	L2	23	8.0	0.275	10.5	LOS B	1.6	42.7	0.38	0.49	0.38	36.1
4	T1	289	8.0	0.275	4.8	LOS A	1.6	42.7	0.38	0.49	0.38	36.2
14	R2	8	8.0	0.275	4.8	LOS A	1.6	42.7	0.38	0.49	0.38	35.1
Approach		319	8.0	0.275	5.2	LOS A	1.6	42.7	0.38	0.49	0.38	36.2
West: John Liner Rd (EB)												
5	L2	163	5.0	0.323	12.1	LOS B	1.9	48.8	0.59	0.73	0.59	34.6
2	T1	51	5.0	0.323	6.4	LOS A	1.9	48.8	0.59	0.73	0.59	34.7
12	R2	104	5.0	0.323	6.5	LOS A	1.9	48.8	0.59	0.73	0.59	33.7
Approach		318	5.0	0.323	9.3	LOS A	1.9	48.8	0.59	0.73	0.59	34.3
All Vehicles		1320	4.9	0.450	7.0	LOS A	3.1	79.2	0.52	0.61	0.52	35.2

Site Level of Service (LOS) Method: Delay & Degree of Saturation (SIDRA). Site LOS Method is specified in the Parameter Settings dialog (Site tab).

Roundabout LOS Method: Same as Signalised Intersections.

Vehicle movement LOS values are based on average delay and v/c ratio (degree of saturation) per movement.

Intersection and Approach LOS values are based on average delay for all movements (v/c not used).

Roundabout Capacity Model: SIDRA Standard.

SIDRA Standard Delay Model is used. Control Delay includes Geometric Delay.

Gap-Acceptance Capacity: SIDRA Standard (Akçelik M3D).

HV (%) values are calculated for All Movement Classes of All Heavy Vehicle Model Designation.

HCM 6th TWSC  
2: McGarigle Rd & Independence Blvd/Site Access

McGarigle Development

Intersection

Int Delay, s/veh	2											
Movement	EBL	EBT	EBR	WBL	WBT	WBR	NBL	NBT	NBR	SBL	SBT	SBR
Lane Configurations		↔			↔			↔			↔	
Traffic Vol, veh/h	1	0	1	22	0	4	3	33	37	7	62	2
Future Vol, veh/h	1	0	1	22	0	4	3	33	37	7	62	2
Conflicting Peds, #/hr	0	0	0	0	0	0	3	0	0	0	0	3
Sign Control	Stop	Stop	Stop	Stop	Stop	Stop	Free	Free	Free	Free	Free	Free
RT Channelized	-	-	None	-	-	None	-	-	None	-	-	None
Storage Length	-	-	-	-	-	-	-	-	-	-	-	-
Veh in Median Storage, #	-	0	-	-	0	-	-	0	-	-	0	-
Grade, %	-	0	-	-	0	-	-	0	-	-	0	-
Peak Hour Factor	71	71	71	71	71	71	71	71	71	71	71	71
Heavy Vehicles, %	0	0	0	2	2	2	9	9	9	2	2	2
Mvmt Flow	1	0	1	31	0	6	4	46	52	10	87	3

Major/Minor	Minor2		Minor1		Major1			Major2				
Conflicting Flow All	195	218	92	189	193	72	93	0	0	98	0	0
Stage 1	112	112	-	80	80	-	-	-	-	-	-	-
Stage 2	83	106	-	109	113	-	-	-	-	-	-	-
Critical Hdwy	7.1	6.5	6.2	7.12	6.52	6.22	4.19	-	-	4.12	-	-
Critical Hdwy Stg 1	6.1	5.5	-	6.12	5.52	-	-	-	-	-	-	-
Critical Hdwy Stg 2	6.1	5.5	-	6.12	5.52	-	-	-	-	-	-	-
Follow-up Hdwy	3.5	4	3.3	3.518	4.018	3.318	2.281	-	-	2.218	-	-
Pot Cap-1 Maneuver	769	684	971	771	702	990	1458	-	-	1495	-	-
Stage 1	898	807	-	929	828	-	-	-	-	-	-	-
Stage 2	930	811	-	896	802	-	-	-	-	-	-	-
Platoon blocked, %								-	-	-	-	-
Mov Cap-1 Maneuver	757	675	968	764	693	990	1454	-	-	1495	-	-
Mov Cap-2 Maneuver	757	675	-	764	693	-	-	-	-	-	-	-
Stage 1	893	799	-	926	826	-	-	-	-	-	-	-
Stage 2	922	809	-	888	794	-	-	-	-	-	-	-

Approach	EB	WB	NB	SB
HCM Control Delay, s	9.2	9.8	0.3	0.7
HCM LOS	A	A		

Minor Lane/Major Mvmt	NBL	NBT	NBR	EBLn1WBLn1	SBL	SBT	SBR
Capacity (veh/h)	1454	-	-	850	792	1495	-
HCM Lane V/C Ratio	0.003	-	-	0.003	0.046	0.007	-
HCM Control Delay (s)	7.5	0	-	9.2	9.8	7.4	0
HCM Lane LOS	A	A	-	A	A	A	A
HCM 95th %tile Q(veh)	0	-	-	0	0.1	0	-



HCM 6th TWSC  
 3: Fruitdale Rd & McGarigle Rd

McGarigle Development

Intersection

Int Delay, s/veh	1.5					
Movement	EBL	EBR	NBL	NBT	SBT	SBR
Lane Configurations						
Traffic Vol, veh/h	36	22	25	213	366	30
Future Vol, veh/h	36	22	25	213	366	30
Conflicting Peds, #/hr	2	0	2	0	0	2
Sign Control	Stop	Stop	Free	Free	Free	Free
RT Channelized	-	None	-	None	-	None
Storage Length	0	-	-	-	-	-
Veh in Median Storage, #	0	-	-	0	0	-
Grade, %	0	-	-	0	0	-
Peak Hour Factor	91	91	91	91	91	91
Heavy Vehicles, %	5	5	4	4	5	5
Mvmt Flow	40	24	27	234	402	33

Major/Minor	Minor2	Major1	Major2			
Conflicting Flow All	711	421	437	0	-	0
Stage 1	421	-	-	-	-	-
Stage 2	290	-	-	-	-	-
Critical Hdwy	6.45	6.25	4.14	-	-	-
Critical Hdwy Stg 1	5.45	-	-	-	-	-
Critical Hdwy Stg 2	5.45	-	-	-	-	-
Follow-up Hdwy	3.545	3.345	2.236	-	-	-
Pot Cap-1 Maneuver	395	626	1112	-	-	-
Stage 1	656	-	-	-	-	-
Stage 2	753	-	-	-	-	-
Platoon blocked, %				-	-	-
Mov Cap-1 Maneuver	382	625	1110	-	-	-
Mov Cap-2 Maneuver	382	-	-	-	-	-
Stage 1	636	-	-	-	-	-
Stage 2	751	-	-	-	-	-

Approach	EB	NB	SB
HCM Control Delay, s	14.4	0.9	0
HCM LOS	B		

Minor Lane/Major Mvmt	NBL	NBT	EBLn1	SBT	SBR
Capacity (veh/h)	1110	-	448	-	-
HCM Lane V/C Ratio	0.025	-	0.142	-	-
HCM Control Delay (s)	8.3	0	14.4	-	-
HCM Lane LOS	A	A	B	-	-
HCM 95th %tile Q(veh)	0.1	-	0.5	-	-

# Collision Data

PRIMARY TRAFFICWAY	MILEPOST	REPORT NUMBER	DATE	TIME	MOST SEVERE INJURY TYPE	# I N J U R I E S	# F A T A L I T I E S	# P E R I C U L O U S I N J U R I E S	FIRST COLLISION TYPE / OBJECT STRUCK	MV DRIVER CONTRIBUTING CIRCUMSTANCE 1 (UNIT 1)	
009	57.43	E406212	2015-03-04	08:31	No Apparent Injury	0	0	0	From opposite direction - one left turn - one straight	Did Not Grant RW to Vehicle	
009	57.43	E584580	2016-09-13	19:21	No Apparent Injury	0	0	0	Entering at angle	Inattention	
009	57.43	3640550	2017-09-11	17:40	Suspected Minor Injury	5	0	0	Entering at angle	Did Not Grant RW to Vehicle	
9	57.43	E773554	2018-02-13	14:23	Suspected Minor Injury	1	0	2	0	From same direction - both going straight - one stopped - rear-end	Driver Distractions Outside Vehicle

**Collision Data Date Range**

Start 1/1/2014  
 End 12/31/2018  
 Total Years 5.00

Intersection	No. Collisions	No. Injury Collisions	Estimated ADT	Collisions per Year	Collisions per MEV
#1: SR-9 @ John Liner Rd/McGarigle Rd	4	2	8,040	0.8	0.27
#2: McGarigle Rd @ Independence Blvd/Access	0	0	670	0	0.00
#3: McGarigle Rd @ Fruitdale Rd	0	0	2,770	0	0.00

# Pipeline Projects

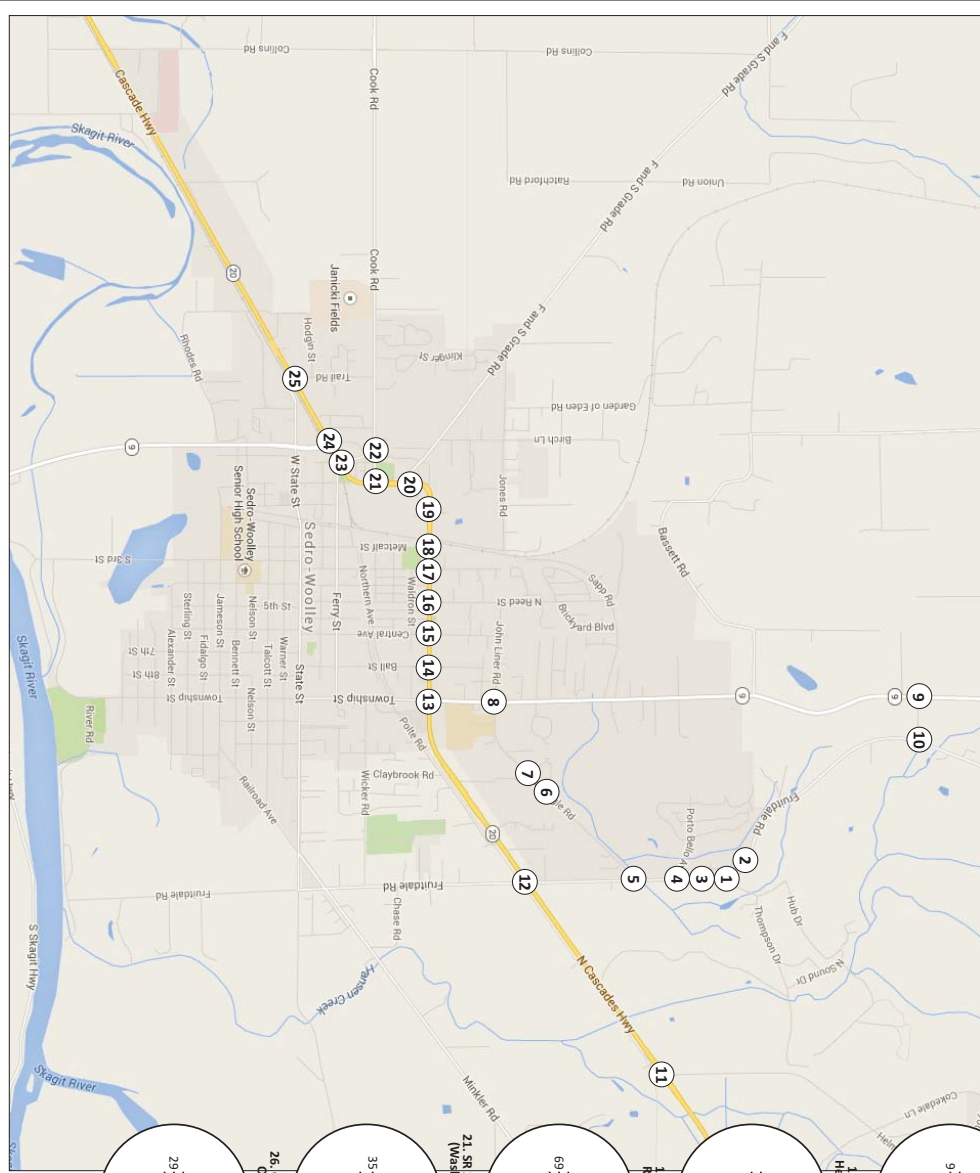

# Intersection PM Peak Hour Trip Impact

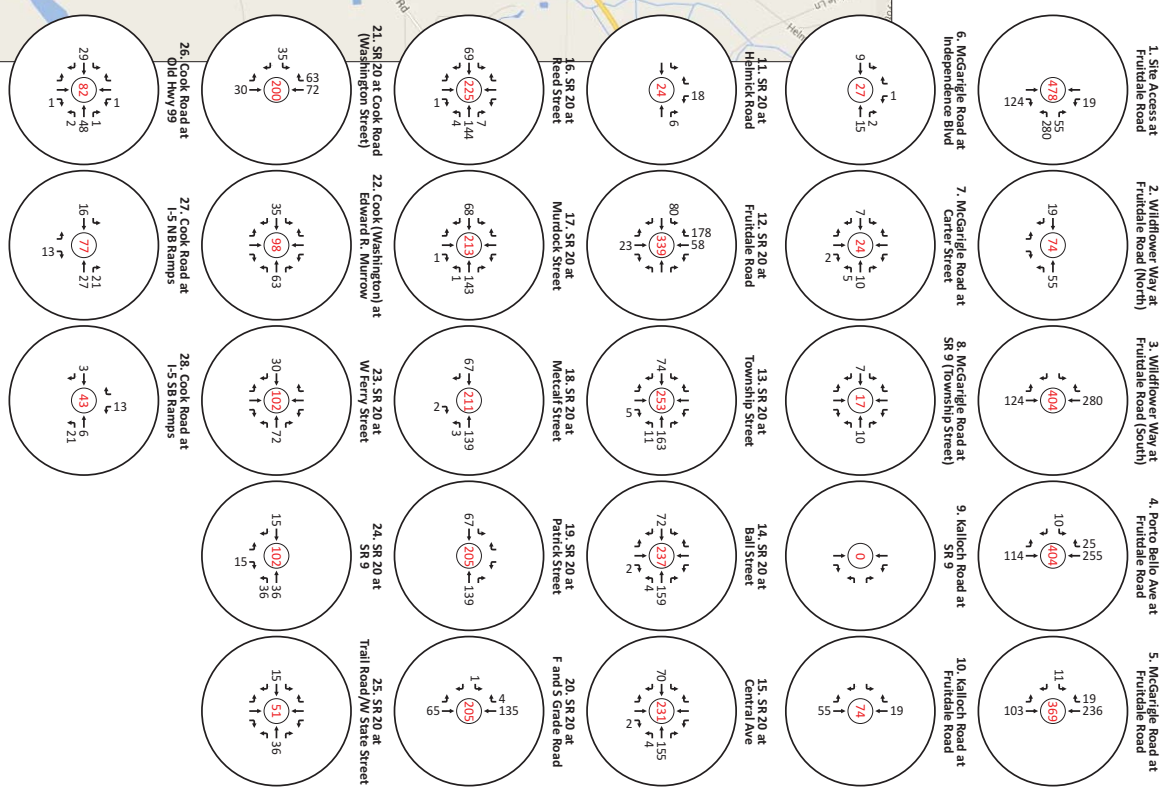
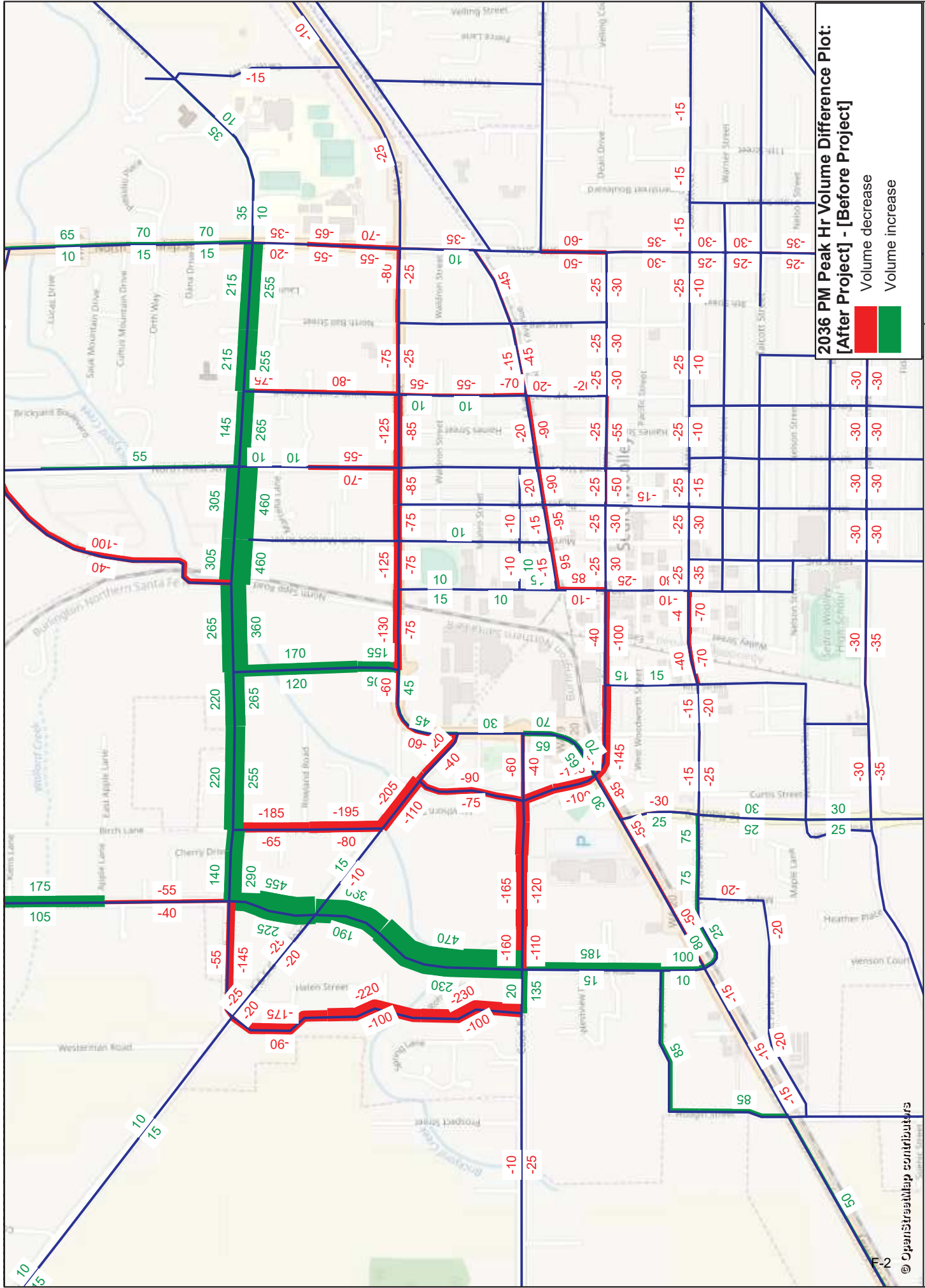

Figure 4.5. High Intensity Site Development Action (Alternative 3) Trip Assignment PM Peak Hour























Volume Difference - 2036 Before and After Jones-John Liner Rd Improvements

Transportation Solutions, Inc.

© OpenStreetMap contributors

HCM 2010 Signalized Intersection Summary  
 208: N Township St. (SR 9) & John Liner Rd./McGarigle Rd.

12/21/2018

												
Movement	EBL	EBT	EBR	WBL	WBT	WBR	NBL	NBT	NBR	SBL	SBT	SBR
Lane Configurations												
Traffic Volume (veh/h)	185	30	110	65	70	35	80	350	50	15	240	150
Future Volume (veh/h)	185	30	110	65	70	35	80	350	50	15	240	150
Number	7	4	14	3	8	18	5	2	12	1	6	16
Initial Q (Qb), veh	0	0	0	0	0	0	0	0	0	0	0	0
Ped-Bike Adj(A_pbT)	0.98		0.96	0.97		0.98	1.00		0.98	0.99		0.99
Parking Bus, Adj	1.00	1.00	1.00	1.00	1.00	1.00	1.00	1.00	1.00	1.00	1.00	1.00
Adj Sat Flow, veh/h/ln	1845	1845	1900	1845	1845	1900	1845	1845	1900	1743	1743	1900
Adj Flow Rate, veh/h	208	34	124	73	79	39	90	393	56	17	270	169
Adj No. of Lanes	1	1	0	1	1	0	1	1	0	1	1	0
Peak Hour Factor	0.89	0.89	0.89	0.89	0.89	0.89	0.89	0.89	0.89	0.89	0.89	0.89
Percent Heavy Veh, %	3	3	3	3	3	3	3	3	3	9	9	9
Cap, veh/h	499	108	395	454	371	183	454	781	111	451	495	310
Arrive On Green	0.32	0.32	0.32	0.32	0.32	0.32	0.50	0.50	0.50	0.50	0.50	0.50
Sat Flow, veh/h	1236	338	1234	1181	1158	572	933	1574	224	870	998	625
Grp Volume(v), veh/h	208	0	158	73	0	118	90	0	449	17	0	439
Grp Sat Flow(s),veh/h/ln	1236	0	1573	1181	0	1730	933	0	1799	870	0	1623
Q Serve(g_s), s	6.4	0.0	3.3	2.2	0.0	2.2	3.2	0.0	7.3	0.6	0.0	8.1
Cycle Q Clear(g_c), s	8.6	0.0	3.3	5.5	0.0	2.2	11.3	0.0	7.3	7.9	0.0	8.1
Prop In Lane	1.00		0.78	1.00		0.33	1.00		0.12	1.00		0.38
Lane Grp Cap(c), veh/h	499	0	503	454	0	554	454	0	893	451	0	806
V/C Ratio(X)	0.42	0.00	0.31	0.16	0.00	0.21	0.20	0.00	0.50	0.04	0.00	0.54
Avail Cap(c_a), veh/h	1040	0	1191	970	0	1310	1040	0	2023	998	0	1825
HCM Platoon Ratio	1.00	1.00	1.00	1.00	1.00	1.00	1.00	1.00	1.00	1.00	1.00	1.00
Upstream Filter(I)	1.00	0.00	1.00	1.00	0.00	1.00	1.00	0.00	1.00	1.00	0.00	1.00
Uniform Delay (d), s/veh	13.9	0.0	11.2	13.3	0.0	10.8	11.5	0.0	7.4	10.0	0.0	7.6
Incr Delay (d2), s/veh	0.6	0.0	0.4	0.2	0.0	0.2	0.2	0.0	0.4	0.0	0.0	0.6
Initial Q Delay(d3),s/veh	0.0	0.0	0.0	0.0	0.0	0.0	0.0	0.0	0.0	0.0	0.0	0.0
%ile BackOfQ(95%),veh/ln	4.1	0.0	2.6	1.3	0.0	1.9	1.5	0.0	6.5	0.3	0.0	6.6
LnGrp Delay(d),s/veh	14.5	0.0	11.5	13.4	0.0	11.0	11.7	0.0	7.8	10.0	0.0	8.2
LnGrp LOS	B		B	B		B	B		A	B		A
Approach Vol, veh/h		366			191			539				456
Approach Delay, s/veh		13.2			11.9			8.5				8.2
Approach LOS		B			B			A				A
Timer	1	2	3	4	5	6	7	8				
Assigned Phs		2		4		6		8				
Phs Duration (G+Y+Rc), s		25.6		17.9		25.6		17.9				
Change Period (Y+Rc), s		4.0		4.0		4.0		4.0				
Max Green Setting (Gmax), s		49.0		33.0		49.0		33.0				
Max Q Clear Time (g_c+I1), s		13.3		10.6		10.1		7.5				
Green Ext Time (p_c), s		8.3		2.9		8.4		2.9				
<b>Intersection Summary</b>												
HCM 2010 Ctrl Delay			9.9									
HCM 2010 LOS			A									



**Table 7. Left-Turn Lane Analysis**

Intersection	Approach Leg	Total DHV <sup>1</sup>	% Total DHV Turning Left	2036 PM LOS (Delay) <sup>2</sup>		Left-Turn Lane Warranted
				Without LT Lane	With LT Lane	
Trail Road & F&S Grade Road	West (EB)	50	10.0%	B (13.3)	B (14.7)	No
	East (WB)	125	24.0%	C (15.8)	B (14.5)	No
	South (NB)	665	0.8%	A (0.1)	A (0.1)	No
	North (SB)	645	3.1%	A (0.8)	A (0.8)	No
Trail Road & Jones Road	West (EB)	185	8.1%	A (1.1)	A (1.1)	No
	East (WB)	660	22.0%	A (4.5)	A (4.5)	<b>Yes</b>
	South (NB)	660	0.8%	D (27.1)	D (25.4)	No
	North (SB)	315	11.1%	D (32.7)	C (24.2)	No
Jones Road & Patrick Street	East (WB)	840	10.1%	A (2.1)	A (2.1)	<b>Yes</b>
	South (NB)	290	12.1%	B (16.1)	B (12.8)	No

<sup>1</sup>Design hourly volume (both directions)

<sup>2</sup>Average LOS and delay by approach

Left-turn lanes are warranted on the east (Jones Rd) approach of the Trail Road and Jones Road intersection, and the east (Jones Rd) approach of the Jones Road and Patrick Street intersection.

## FINDINGS AND RECOMMENDATIONS

Findings and recommendations are summarized below.

- Single-lane roundabouts are the preferred intersection control alternative at the intersections of:
  - Cook Road and Trail Road
  - N Township Road (SR 9) and John Liner Road/McGarigle Road.
- A left-turn lane is warranted at the following two locations:
  - East (Jones Rd) approach of Trail Road and Jones Road intersection.
  - East (Jones Rd) approach of Jones Road and Patrick Street intersection.

Attachment 1. 2036 PM Peak Hour Volume With Jones/John Liner Road Corridor

Attachment 2. 2036 PM Peak Hour Volume Difference, Before and After Jones/John Liner Road Corridor

Attachment 3. Conceptual Roundabout Layouts

Attachment 4. Signal Warrant Reports

Attachment 5: Intersection LOS Reports

Attachment 6: Left-Turn Storage Guidelines

# **Channelization Warrants**

# GIBSON TRAFFIC CONSULTANTS

## McGarigle Road @ Site Access

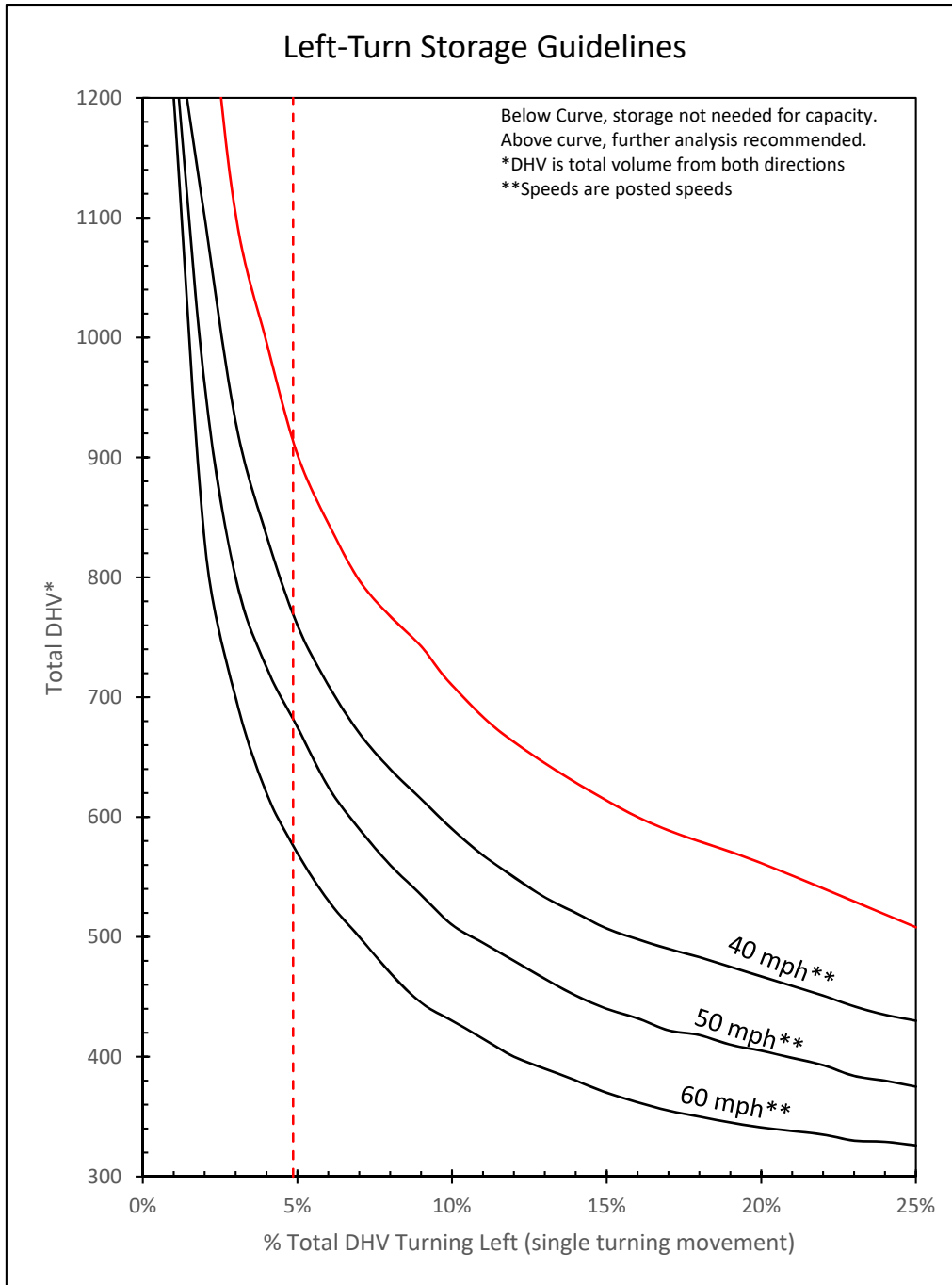

Total DHV: 144  
Left Turns: 7  
% Left: 4.9%

Posted Speed: 25 mph

Based on WSDOT July 2018 Design Manual: Exhibit 1310-7a, Page 1310-13.

# GIBSON TRAFFIC CONSULTANTS

## McGarigle Road @ Site Access

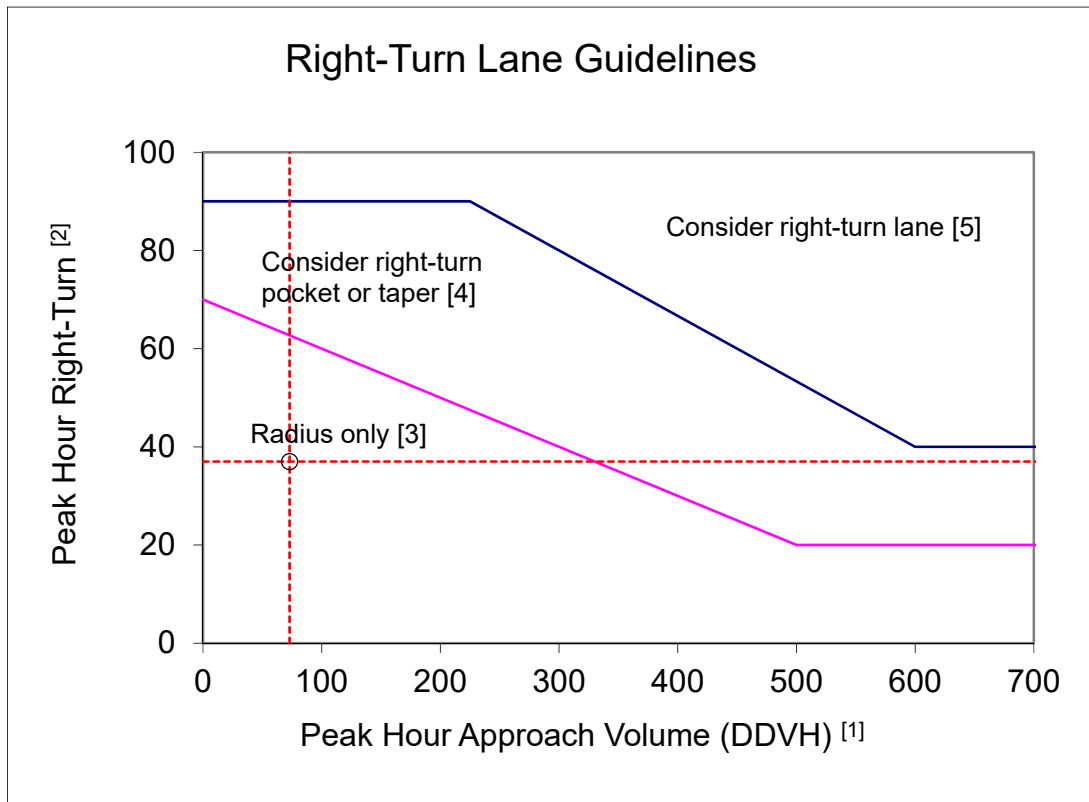

Right Turn Volume: 37 [DDHV]      Posted Speed: 25 mph  
 Adjusted Right Turn Volume: 37 [DDHV]  
 Pk Hr Curb Ln Approach Vol: 73 [DDHV]

[1] For two-lane highways, use the peak hour DDHV (through + right turn).  
 For multilane, high speed highways (posted speed 45 mph or above), use the right-lane peak hour approach volume (through + right turn).

[2] When all three of the following conditions are met, reduce the right-turn DDHV by 20:  
 - The posted speed is 45 mph or less  
 - The right-turn volume is greater than 40 VPH  
 - The peak hour approach volume (DDHV) is less than 300 VPH.

[3] For right-turn corner design, see Exhibit 1310-6.

[4] For right-turn pocket or taper design, see Exhibit 1310-12.

[5] For right-turn lane design, see Exhibit 1310-13.

Based on WSDOT July 2018 Design Manual: Exhibit 1310-11, Page 1310-27.

# **Sedro Woolley Six-Year TIP**

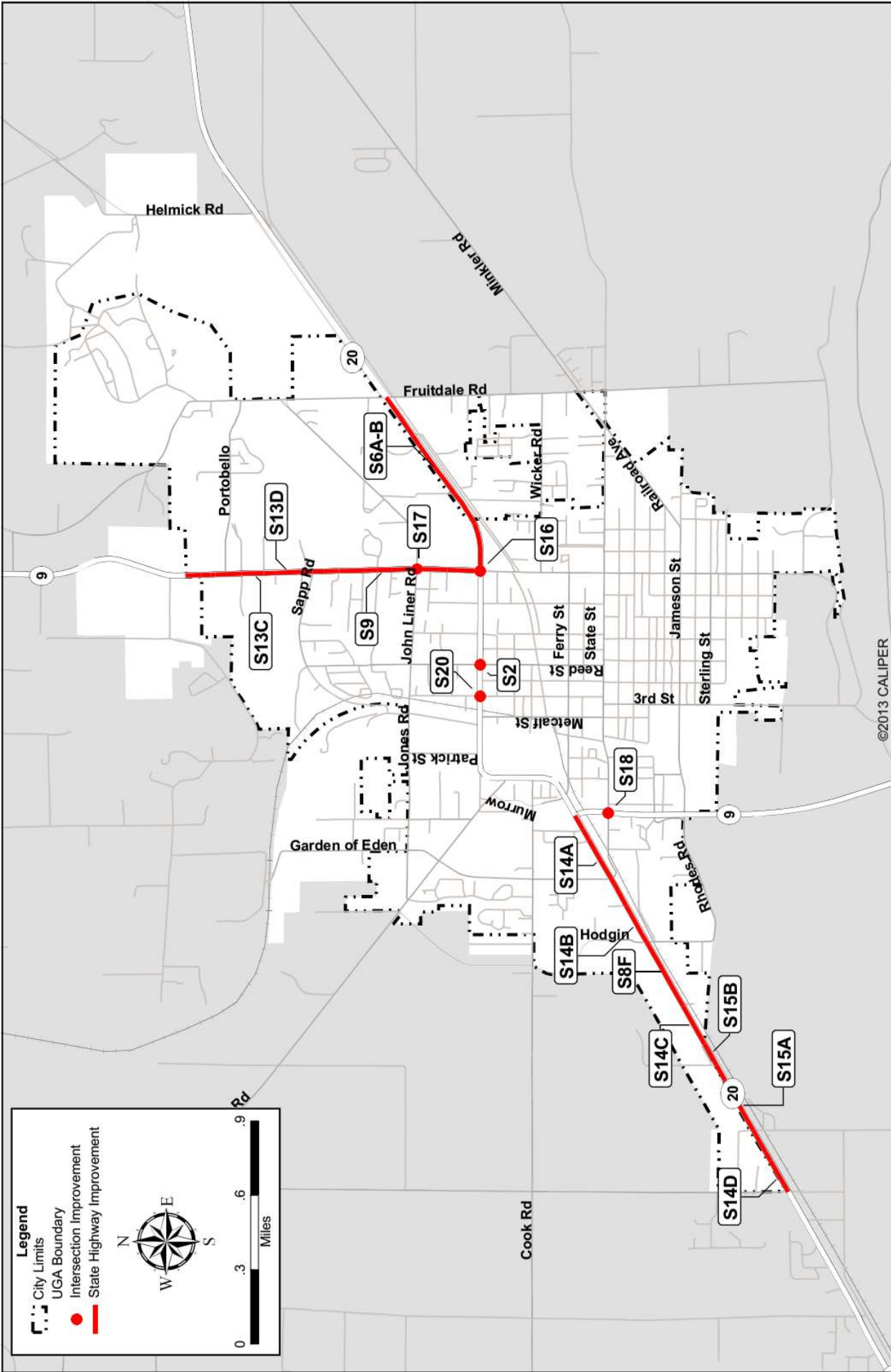

Figure 7  
 State Highway Improvement Projects - Corrected 5/3/2018

City of Sedro-Woolley



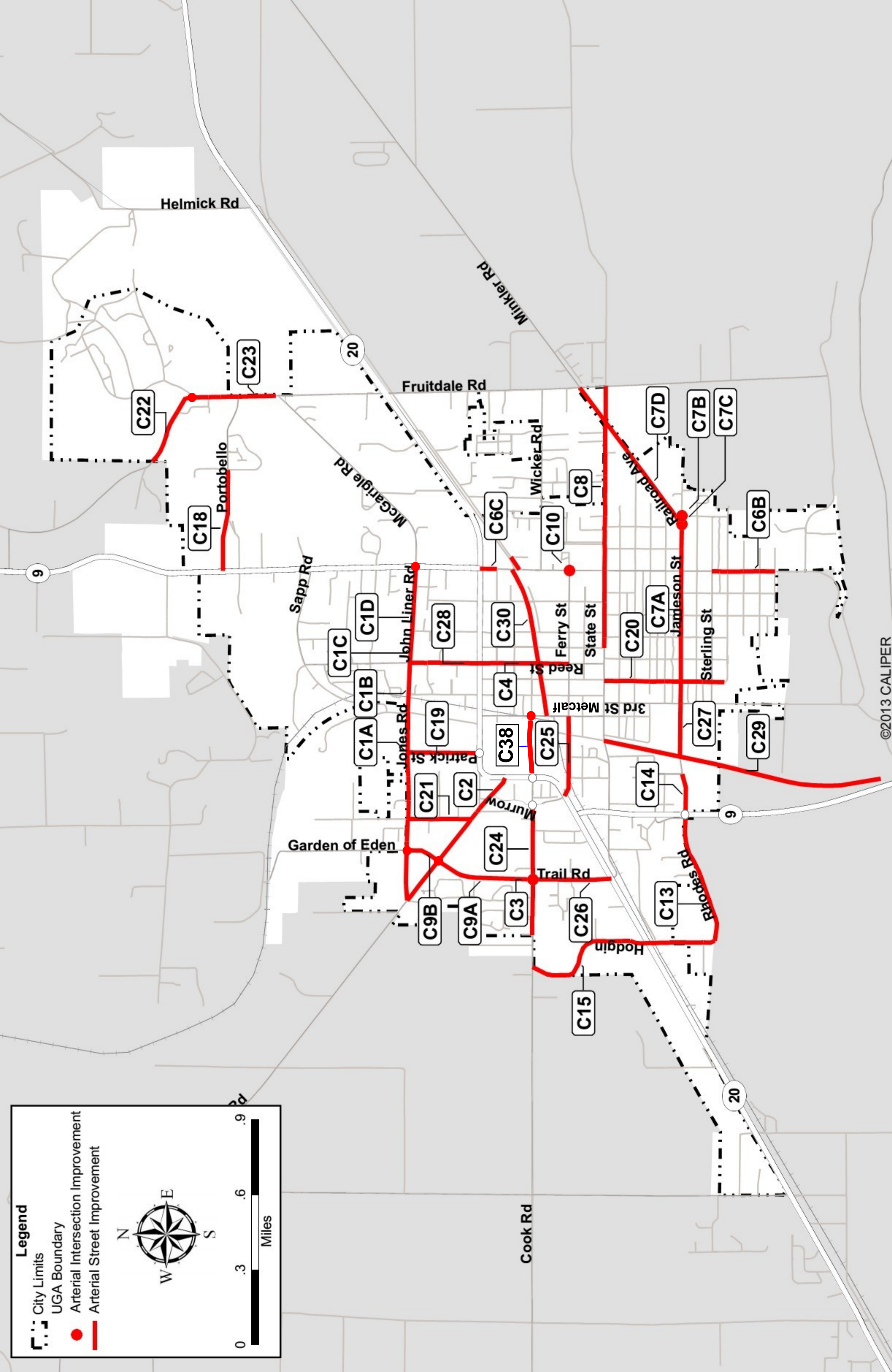

Figure 8

# Arterial Improvement Projects - 2017 Update

City of Sedro-Woolley



**2019-2024 TIP PROJECT LIST**

**Sedro-Woolley Transportation Improvement Program and Projects**

REVISED: 5/3/2018

MAP ID (1)	2019 - 2023 TIP CN Project	2019 - 2023 TIP CN Year	2019 - 2024 TIP Priority No.	Project Name	Project Limits	Project Description	Priority	In Existing TIP (2019) (2)	Total Cost 2018 (\$1,000's) (3/4)	Sedro-Woolley 2018 Cost (\$1,000's) (3)	TIP Eligible (Y/N)	JONES-JOHN LINER-TRAIL RD CORRIDOR PROJECT
C1E	SW33	2019	1	Jones/John Liner/Trail Road Corridor Scoping Study	Cook Road to SR9 MP 57.43 John Liner Road	Planning level project to define the scope of the Jones/John Liner/Trail Road Corridor in order to establish an alternative east-west corridor to relieve congestion on SR20 between SR9 South and SR9 North.	High	Yes	200	125	Yes	
C1C	SW06A	2020	2	John Liner Road, Reed to Township Bicycle/Pedestrian Improvements	Reed Street to SR9/Township Street (2,000 LF)	Construct shared use path on the north side of John Liner Road from Reed to Township, including drainage and illumination.	High	Yes	583	87	Yes	200
C1B	SW06	2019	3	Jones/John Liner RR Undercrossing	Sapp Road to Reed Street (1,000 ft)	New BNSF RR undercrossing and new major collector from East Jones Road to John Liner Road, including drainage, curbs, sidewalks, HMA, pavement markings and illumination.	High	Yes	7,700	1,925	Yes	
S15B	NEW SW69	2028	4	SR20 West Lane Widening & Safety Improvements Project 1	Hollcamp Road / Hodgkin Street	Improve and widen to 3 lanes (2,400 LF); add Brickyard Creek crossing.	High	Yes	600	150	Yes	7,700
C33B	SW49	2023	5	Jameason Street Overlay Project 2	3rd Street to Township (2,800 LF)	Grnd and overlay; upgrade ADA Ramps	High	Yes	476	119	No	
C19	SW20	2020	6	Patrick Street Arterial Extension	Michael Street to East Jones Road (1,200 LF)	New major collector with drainage, curbs, sidewalks, HMA, pavement markings, illumination.	Medium	Yes	2,100	2,100	Yes	
C26	SW38	2019	7	Trail Road Overlay	SR20 to Cook Road (1,600 LF)	Grnd and overlay	High	Yes	272	41	No	2,100
NEW C13A	NEW SW64	NEW	8	Rhodes Road Overlay	SR20 to City Limits (510 LF)	Grnd and overlay	High	No	54	8	No	
S16	SW33	2021	9	SR20/SR9N-Township Intersection Improvements	SR20 MP 66.08; SR9 MP 57.17	Intersection channelization improvements to allow concurrent north-south left turns and improve signal sequencing, including sidewalk/path improvements.	High	Yes	828	207	Yes	
S2	SW35	2021	10	SR20 / Reed Street Intersection Improvements	SR20 MP 65.70 to 65.72	Intersection improvements to restrict minor approach motions to right-in/right-out.	High	Yes	50	13	Yes	
C24	SW24	2020	11	Cook Road Overlay	West City Limits to Crossroads (2,200 LF)	Grnd and overlay	High	Yes	449	67	No	
C3	SW25	2022	12	Cook Road / Trail Road Intersection Improvements	Trail Road to Trail Road	Reconstruct intersection with traffic signal or Roundabout.	High	Yes	1,000	250	Yes	
S14C	SW42	2023	13	SR20/Cascade Trail West Extension Phase 2A Hollcamp Road to Hodgkin Road LF)	SR20 MP 63.64 Hollcamp Rd to SR20 MP 64.21 Hodgkin Road (3,000 LF)	Construct a shared use path along the north side of SR20 from Hollcamp Road to Hodgkin Road	Medium	Yes	840.5	78	Yes	1,000
C28	SW40	2021	14	North Reed Street Overlay Project 1	SR20 to John Liner Road (1,400 ft)	Grnd and overlay; upgrade ADA ramps.	High	Yes	315	47	No	
C1A	SW07	2023	15	Jones Road Arterial Improvements	F&S Grade Rd to Sapp Road (4,000 LF)	Reconstruct to major collector section including drainage, curbs, sidewalk, shared use path, HMA, pavement markings and illumination.	High	Yes	3,200	800	Yes	
S18	SW45	2023	16	SR 9 / W State Street Intersection Improvements	SR9 MP 55.75	Intersection improvements to add a dedicated right turn lane to the west leg.	High	Yes	250	63	Yes	3,200





**2019-2024 TIP PROJECT LIST**

REVISED: 5/3/2018

**Sedro-Woolley Transportation Improvement Program and Projects**

MAP ID (i)	2019 - 2024 TIP Project	2018 - 2023 TIP CN Year	2019 - 2024 TIP CN Year	2019 - 2024 TIP Priority No.	Project Name	Project Limits	Project Description	Priority	In Existing TIP (2019)? (ii)	Total Cost 2018 (\$1,000's) (3)(4)	Sedro-Woolley 2018 Cost (\$1,000's) (3)	TIF Eligible (Y/N)	JONES-JOHN LINER-TRAIL RD CORRIDOR PROJECT	
C18	SW21	2023	2023	17	Portobello Street Arterial Extension	SRSIN Township Street to Cascadia Drive (2,100 LF)	New major collector connecting Fruitdale to SRSIN Township, including drainage, curbs, sidewalks, HMA, pavement markings and illumination.	Medium	Yes	1,700	425	Yes		
C33A	SW48	2022	2023	18	Jameson Street Overlay Project 1	800' W of Batey to 3rd Street (800 LF)	Grind and overlay; upgrade ADA ramps.	High	Yes	213	32	No		
C8A	NEW SW65	2024	2024	19	Trail Road Arterial Extension	Cook Rd to F&S Grade (2,200 LF)	Construct new major collector.	High	Yes	4,000	1,000	Yes		
C8B	NEW SW56	2024	2024	20	Trail Rd - Garden of Eden Rd Extension	F&S Grade to Jones Rd (770 LF)	Construct new major collector. (Will require Functional Classification).	High	Yes	850	213	Yes	4,000	
C34	NEW SW57	2024	2024	21	Stapp Road Overlay	Road Street to SR 9/Township (2,000 LF)	Grind and overlay; upgrade ADA ramps.	High	Yes	266	40	No	850	
<b>SUBTOTAL 2019-2024 ALL PROJECTS</b>											<b>25,947</b>	<b>7,789</b>	<b>19,050</b>	
<b>SUBTOTAL 2019-2024 - TIF ELIGIBLE PROJECTS</b>											<b>23,902</b>	<b>7,435</b>		
<b>SUBTOTAL 2019-2024 - OTHER PROJECTS</b>											<b>2,045</b>	<b>354</b>		



**2025-2038 TIP PROJECT LIST**

REVISED: 5/1/2018

**Sedro-Woolley Transportation Improvement Program and Programs**

MAP ID (1)	2019 - 2024 TIP Project	2018 - 2023 TIP CN Year	2019 - 2024 TIP CN Year	2019 - 2024 TIP Priority No.	Project Name	Project Limits	Project Description	Priority	In Existing TIP (2018) (2)	Total Cost 2018 (\$1,000's) (3)	Sedro-Woolley 2018 Cost (\$1,000's) (3)	TIF Eligible (Y/N)	JONES-JOHN LINER-TRAIL RD CORRIDOR PROJECT
S17	SR29/Township St & John Liner/McGarigle Intersection Improvements	2025	2025		SR29/Township St & John Liner/McGarigle Intersection Improvements	SR9 MP 57.43	Intersection Improvements, including signalization or Single Lane Roundabout.	Medium	Yes	1,000	250	Yes	
S13C	SR31 Pedestrian/Bicycle Safety Improvements	2025	2025		SR31 Pedestrian/Bicycle Safety Improvements	West Side of SR9 M 57.99 Park Cottage to MP 58.30 North City Limits (1,240 LF)	Construct bicycle lane and sidewalk improvements on the west side of SR9 from Park Cottage Place to the North City Limits.	Medium	Yes	434	109	Yes	1,000
C35	West State Street Overlay	2025	2025		West State Street Overlay	SR 20 to SR 9 (1,500 LF x 30 LF)	Grind and overlay.	High	Yes	259	65	No	
C1D	John Liner Road Arterial Improvements	2026	2026		John Liner Road Arterial Improvements	Reed Street to SR9/Township Street (2,000 LF)	Reconstruct John Liner Road to major collector section including drainage, curbs, sidewalk, shared use path, HMA, pavement markings and illumination.	Medium	Yes	1,600	400	Yes	
C36	North Reed Street Overlay Project 2	2026	2026		North Reed Street Overlay Project 2	John Liner Road to Sapp Road (2,200 LF)	Grind and overlay.	High	Yes	400	100	No	1,600
C7A	Jameson St Arterial Improvements	2027	2027		Jameson St Arterial Improvements	600' E. of Baley to Railroad St (4,500 LF)	Widen and rebuild Jameson St to secondary standards including 3 lanes, curb & gutter, bike lanes, planter strip, and sidewalks. Some right-of-way may be required.	Medium	Yes	3,600	900	Yes	
C7B	Jameson St / 11th St Intersection Improvements	2027	2027		Jameson St / 11th St Intersection Improvements	Intersection	Change access on 11th St to right-in right-out	Medium	Yes	70	18	Yes	
C37 NEW	Annual Overlay Project	2027	2027		Annual Overlay Project	TBD	Grind and overlay.	High	Yes	400	100	No	
NEW-S15B	SR20 West Lane Widening & Safety Improvements	2028	2028		SR20 West Lane Widening & Safety Improvements	Holtcamp Road / Hodgkin Street	Improve and widen to 3 lanes (2,400 LF)	High	Yes	600	150	Yes	
C7C	Railroad St / Jameson St Intersection Improvements	2028	2028		Railroad St / Jameson St Intersection Improvements	Intersection	Improve intersection. Construct roundabout.	Medium	Yes	750	188	Yes	
NEW	Annual Overlay Project	2028	2028		Annual Overlay Project	TBD	Grind and overlay.	High	Yes	400	100	No	
C38	Cook Road Arterial Extension	2029	2029		Cook Road Arterial Extension	SR20 to Metcalf Street (1,050 LF)	New major collector with drainage, curbs, sidewalks, HMA, pavement markings, illumination	Medium	Yes	825	206	Yes	
S15A	SR20 West Lane Widening & Safety Improvements	2029	2029		SR20 West Lane Widening & Safety Improvements	Hospital Drive / Holtcamp Road	Improve and widen to 3 lanes (1,300 LF)	Medium	Yes	325	81	Yes	
C7D	Railroad St Arterial Improvements	2029	2029		Railroad St Arterial Improvements	Jameson St to Fruitdale Rd (3,600 lf)	Widen and rebuild Railroad St to secondary arterial standards including 3 lanes, curb & gutter, bike lanes, planter strip, and sidewalks. Some right-of-way may be required.	Medium	Yes	2,880	720	Yes	
NEW	Annual Overlay Project	2029	2029		Annual Overlay Project	TBD	Grind and overlay.	High	Yes	400	100	No	
C4	Reed Street Arterial Improvements	2030	2030		Reed Street Arterial Improvements	Ferry Street to SR 20 (1,800 LF)	Reconstruct street to arterial standards with new curbs, sidewalks, ADA facilities, HMA pavement and pavement markings.	Medium	Yes	1,440	360	Yes	



**2025-2038 TIP PROJECT LIST**

**Sedro-Woolley Transportation Improvement Program and Programs**

REVISED: 5/1/2018

MAP ID (1)	2019 - 2024 TIP Project	2018 - 2023 TIP CN Year	2019 - 2024 TIP CN Year	2019 - 2024 TIP Priority No.	Project Name	Project Limits	Project Description	Priority	In Existing TIP (2018) (2)	Total Cost 2018 (\$1,000's) (3)(4)	Sedro-Woolley 2018 Cost (\$1,000's) (3)	TIF Eligible (Y/N)	JONES-JOHN LINER-TRAIL RD CORRIDOR PROJECT
NEW		2030	2030		Annual Overlay Project	TBD	Grind and overlay.	High	Yes	400	100	No	
C2	SW09	2031	2031		F&S Grade Rd Arterial Improvements	SR 20 MP 65.16 to West City Limits/Jones Road (3,700 LF)	Reconstruct F&S Grade Road to arterial standards including drainage, curbs, sidewalk, combined bicycle/pedestrian path, HMA, pavement markings and illumination.	Medium	Yes	2,960	740	Yes	
S20	SW44	2031	2031		SR20/Central Ave Intersection Improvements	SR20 MP 65.63	Intersection improvements or RIRO	Medium	Yes	150	38	Yes	
NEW		2031	2031		Annual Overlay Project	TBD	Grind and overlay.	High	Yes	400	100	No	
S14D	SW43	2032	2032		SR20/Cascade Trail West Extension Phase 2B Collins Road to Hollcamp Road	SR20 MP 63.06 Collins Rd to MP 63.64 Hollcamp Rd (3,100 LF)	Construct a shared use path along the north side of SR20 from Collins Road to Hollcamp Road	Medium	Yes	620	155	Yes	
S8F	SW02F	2032	2032		SR 20 Stormwater Conveyance System Upgrade	SR20 MP 63.64 Hollcamp Road to MP 64.21 Hodgkin Road (72 IN - 984 LF)	Upgrade the SR20 Stormwater Conveyance System from Hollcamp Road to Hodgkin Road to correct existing capacity issues. Extends and completes undersized portions of the stormwater identified in the SR20/Cook Road Realignment and Grind and overlay.	Medium	Yes	300	300	No	
NEW		2032	2032		Annual Overlay Project	TBD	Grind and overlay.	High	Yes	400	100	No	
C8		2033	2033		State St Sidewalks	Haines to E City Limits (3,000 LF)	Construct sidewalks, ADA ramps, and other pedestrian improvements along north side of State St.	Low	Yes	540	135	Yes	
NEW		2033	2033		Annual Overlay Project	TBD	Grind and overlay.	High	Yes	400	100	No	
C10		2034	2034		Township St / Ferry St Intersection Improvements	Intersection	Construct intersection improvements to include an all-way stop.	Medium	Yes	50	13	No	
C13		2034	2034		Rhodes Rd Arterial Improvements	SR 9 to SR 20 (4,000 LF)	Reconstruct roadway to secondary arterial standards including curbs & gutter, bike lanes, sidewalk, and stormwater facilities. (City portion 500 LF, County portion 3,500 LF)	Low	Yes	3,200	800	Yes	
NEW		2034	2034		Annual Overlay Project	TBD	Grind and overlay.	High	Yes	400	100	No	
C15		2035	2035		Hodgkin Road Arterial Extension Project	SR 20 to Cook Rd (2,100 LF)	Construct new collector arterial including drainage, curbs, sidewalks, HMA, pavement markings and illumination. Grind and overlay.	Low	Yes	2,225	556	Yes	
NEW		2035	2035		Annual Overlay Project	TBD	Grind and overlay.	High	Yes	400	100	No	
C20		2036	2036		4th Street, Alexander to State Arterial	Alexander to State (1,600 LF)	Reconstruct to major collector standards to replace 3rd Street as N-S Arterial	Low	Yes	1,300	325	Yes	
NEW		2036	2036		Annual Overlay Project	TBD	Grind and overlay.	High	Yes	400	100	No	



**2025-2038 TIP PROJECT LIST**

REVISED: 5/1/2018

**Sedro-Woolley Transportation Improvement Program and Programs**

2019 - 2024 TIP Project ID (1)	2018 - 2023 TIP CN Year	2019 - 2024 TIP CN Year	2019 - 2024 TIP Priority No.	Project Name	Project Limits	Project Description	Priority	In Existing TIP (2018)? (2)	Total Cost 2018 (\$1,000's) (3)(4)	Sedro-Woolley 2018 Cost (\$1,000's) (3)	TIF Eligible (Y/N)	JONES-JOHN LINER-TRAIL RD CORRIDOR PROJECT
S9	2037	2037		SR9/North Township St Arterial Improvements	SR 20 to city limits (5,900 LF)	Planning Phase - Reconstruct to minor arterial standards including 3 lanes, curb & gutter, bike lanes, planter strip, sidewalks. Some right-of-way may be required. 2016 RTIP EST CN \$4.7M	Medium	Yes	100	25	Yes	
C6B	2037	2037		South Township St Arterial Improvements Project	Dunlop to Sterling St (1,300 LF)	Reconstruct to major collector standards.	Low	Yes	1,040	260	No	
C21	2037	2037		Garden of Eden Rd Arterial Improvements	F&S Grade Road to Jones Road (1,300 LF)	Reconstruct to major collector standards.	Low	Yes	1,040	260	Yes	
C29	2037	2037		Centennial Trail South: County or BNSF RW	South City Limits to Ferry Street (3,700 LF)	County ROW south of Jameson - improve trail with gravel or pavement. BNSF ROW north of Jameson - remove abandoned rail and lee and improve as a trail. ROW acquisition or easement required.	Medium	Yes	500	125	No	
C30	2037	2037		Cascade Trail East Extension	Melcalf Street to 400' East of Township Street (4,420 LF)	Construct a shared use path on former BNSF RW	Medium	Yes	100	25	No	
S13D	2037	2037		SR9/Centennial Trail Pedestrian/Bicycle Safety Improvements	East Side of SR9 MP 57.59 Summer Meadows Place to MP 58.30 North City Limits (4,100 LF)	Construct bicycle lane and sidewalk improvements on the east side of SR9 from Summer Meadows Court to the North City Limits, including a pedestrian crossing bridge at Brickyard Creek.	Medium	Yes	1,700	425	Yes	
NEW	2037	2037		Annual Overlay Project	TBD	Grind and overlay.	High	Yes	400	100	No	
NEW	NEW	3038		NEW PROJECT TBD	TBD	TBD	Low		500	125		
NEW	NEW	3038		Annual Overlay Project	TBD	Grind and overlay.	High	Yes	400	100	No	
<b>SUBTOTAL 2025-2038 PROJECTS</b>									<b>35,308</b>	<b>9,052</b>		<b>2,600</b>
<b>SUBTOTAL 2025-2038 - TIF ELIGIBLE PROJECTS</b>									<b>28,259</b>	<b>28,259</b>		<b>-</b>
<b>SUBTOTAL 2025-2038 - OTHER PROJECTS</b>									<b>7,049</b>	<b>1,987</b>		<b>-</b>

# **Sedro Woolley Traffic Impact Fee Documents**



### Transportation Impact Fee Project List

ID	Project Name	Project Limits	Description	Total Est. Cost (\$)
C14	Jameson Arterial Extension	SR 9 / Batey Rd	New arterial segment	3,020,000
S14A	SR20/Cascade Trail West Extension Ph.1A	Trail Rd / SR 9 South	Shared use path	575,000
S14B	SR20/Cascade Trail West Extension Ph.1B	Hodgin Rd / Trail Rd	Shared use path	288,000
C22	Fruitdale Rd Arterial Improvements	Portobello / North City Limit	Reconstruct to arterial standards incl. roundabout at Northern State Rd	2,320,000
C1B	Jones/John Liner RR Undecrossing	Sapp Rd / Reed St	New BNSF undercrossing and new arterial from E Jones Rd to John Liner Rd	7,700,000
C1C	John Liner Bike/Ped Impr	Redd St / SR 9	Complete Streets completion	555,000
C19	Patrick St Extension	Michael St/E Jones St	New major collector w/sidewalks	2,100,000
C1A	Jones Rd Improvements	F&S Grade Rd / Sapp Rd	Reconstruct to arterial section including sidewalk & shared use path	3,200,000
S16	SR20 & SR9 (Township) Intersection Impr.		Channelization and signal improvements	1,000,000
C18	Portobello Arterial Extension	Township / Cascadia	New major collector connecting Fruitdale w/ SR 9	1,700,000
S2	SR20 & Reed St Intersection Impr.		RIRO access restriction	50,000
S18	SR 9 / W State St Intersection Impr		Intersection improvements	250,000
C3	Cook Rd / Trail Rd Intersection Improvements		Intersection improvements	1,000,000
C9A	Trail Rd Arterial Extension	Cook Rd / F&S Grade	Construct new minor arterial	4,000,000
C9B	Trail Rd – Garden of Eden Rd Extension	F&S Grade / Jones Rd	Construct new minor arterial	850,000
S13C	SR9N Ped/Bike Safety Improvements	Park Cottage / N City Limits	Bike lane & sidewalk improvements	434,000
S17	Township St (SR 9) & John Liner/McGarigle Rd Intersection Improvements		Intersection improvements	1,000,000
C1D	John Liner Rd Arterial Improvements	Reed St / Township St	Reconstruct to arterial section	1,600,000
S6 A-B	SR 20 East Lane Widening & Safety Improvements	SR 9 / Fruitdale Rd	Improve and widen to 3 lanes	960,000
C7A	Jameson St Arterial Improvements	600' e/o Batey to Railroad St	Widen to arterial standards w/3 lanes, bike lane, sidewalk	3,600,000
C7B	Jameson / 11 <sup>th</sup> St Intersection Improvements		Change access to RIRO	70,000
C7C	Railroad St / Jameson Intersection Improvements		Intersection improvements to include new roundabout	750,000
C7D	Railroad St Arterial Improvements	Jameson St / Fruitdale	Reconstruct to arterial standards incl. 3 lanes, bike lanes, sidewalks	2,880,000
C2	F&S Grade Rd Arterial Improvements	SR20 MP 65.16 / Jones Rd	Reconstruct to arterial standards	2,960,000
S14C	SR20/Cascade Trail West Extension Ph.2A	Holtcamp Rd/Hodgin Rd	Shared use path	600,000
S20	SR 20 / Central Ave Intersection Improvements		Intersection improvements or RIRO	150,000
S14D	SR20/Cascade Trail West Extension Ph.2B	Collins Rd/Holtcamp Rd	Shared use path	620,000

<b>ID</b>	<b>Project Name</b>	<b>Project Limits</b>	<b>Description</b>	<b>Total Est. Cost (\$)</b>
C13	Rhodes Rd Arterial Impr	SR 9 / SR 20	Reconstruct to arterial standards incl. bike lanes, sidewalks	3,200,000
C15	Hodgin Rd Arterial Ext.	SR 20 / Cook	New collector arterial	2,225,000
S9	SR9/N Township St Arterial Improvements	SR 20 / City limits	Planning phase – reconstruct to arterial standards incl. 3 lanes, bike lanes, sidewalk	100,000
S13D	SR9 / Centennial Trail Ped/Bike Safety Improvements	Summer Meadows P1 / North City Limits	Construct bicycle lane and sidewalk improvements incl. ped crossing bridge at Brickyard Crk	1,700,000